

JVC



DVD DIGITAL THEATER SYSTEM

TH-A30

Consists of XV-THA30, SP-XA30, SP-XSA30 and SP-WA30

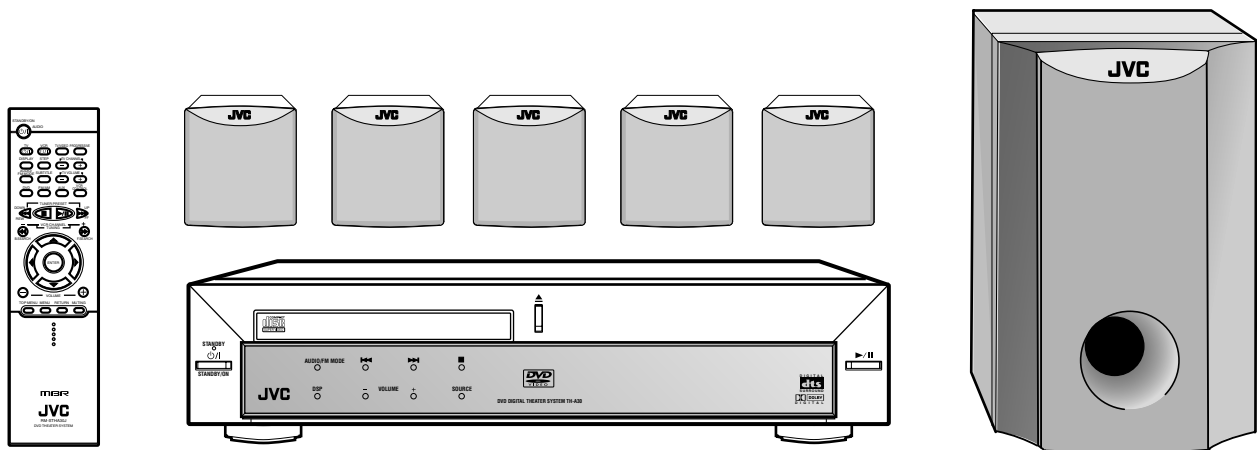

INSTRUCTIONS

For Customer Use:

Enter below the Model No. and Serial No. which are located either on the rear, bottom or side of the cabinet. Retain this information for future reference.

Model No. _____

Serial No. _____

Warnings, Cautions and Others



CAUTION

RISK OF ELECTRIC SHOCK
DO NOT OPEN



CAUTION: TO REDUCE THE RISK OF ELECTRIC SHOCK,
DO NOT REMOVE COVER (OR BACK)
NO USER SERVICEABLE PARTS INSIDE.
REFER SERVICING TO QUALIFIED SERVICE PERSONNEL.

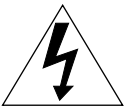

The lightning flash with arrowhead symbol, within an equilateral triangle is intended to alert the user to the presence of uninsulated "dangerous voltage" within the product's enclosure that may be of sufficient magnitude to constitute a risk of electric shock to persons.



The exclamation point within an equilateral triangle is intended to alert the user to the presence of important operating and maintenance (servicing) instructions in the literature accompanying the appliance.

WARNING: TO REDUCE THE RISK OF FIRE OR ELECTRIC SHOCK, DO NOT EXPOSE THIS APPLIANCE TO RAIN OR MOISTURE.

CAUTION

To reduce the risk of electrical shocks, fire, etc.:

1. Do not remove screws, covers or cabinet.
2. Do not expose this appliance to rain or moisture.

Caution — STANDBY/ON \odot /I switch!

Disconnect the mains plug to shut the power off completely. The STANDBY/ON \odot /I switch in any position does not disconnect.

Note to CATV system installer:

This reminder is provided to call the CATV system installer's attention to Section 820-40 of the NEC which provides guidelines for proper grounding and, in particular, specifies that the cable ground shall be connected to the grounding system of the building, as close to the point of cable entry as practical.

For U.S.A.

This equipment has been tested and found to comply with the limits for a Class B digital device, pursuant to part 15 of the FCC Rules. These limits are designed to provide reasonable protection against harmful interference in a residential installation.

This equipment generates, uses and can radiate radio frequency energy and, if not installed and used in accordance with the instructions, may cause harmful interference to radio communications. However, there is no guarantee that interference will not occur in a particular installation. If this equipment does cause harmful interference to radio or television reception, which can be determined by turning the equipment off and on, the user is encouraged to try to correct the interference by one or more of the following measures:

Reorient or relocate the receiving antenna.

Increase the separation between the equipment and receiver.

Connect the equipment into an outlet on a circuit different from that to which the receiver is connected.

Consult the dealer or an experienced radio/TV technician for help.

IMPORTANT FOR LASER PRODUCTS

1. CLASS 1 LASER PRODUCT

2. **CAUTION:** Visible laser radiation when open and interlock failed or defeated. Avoid direct exposure to beam.

3. **CAUTION:** Do not open the top cover. There are no user serviceable parts inside the Unit; leave all servicing to qualified service personnel.

Caution: Proper Ventilation

To avoid risk of electric shock and fire and to protect from damage.

Locate the apparatus as follows:

- Front: No obstructions open spacing.
- Sides: No obstructions in 10 cm from the sides.
- Top: No obstructions in 10 cm from the top.
- Back: No obstructions in 15 cm from the back
- Bottom: No obstructions, place on the level surface.

In addition, maintain the best possible air circulation as illustrated.

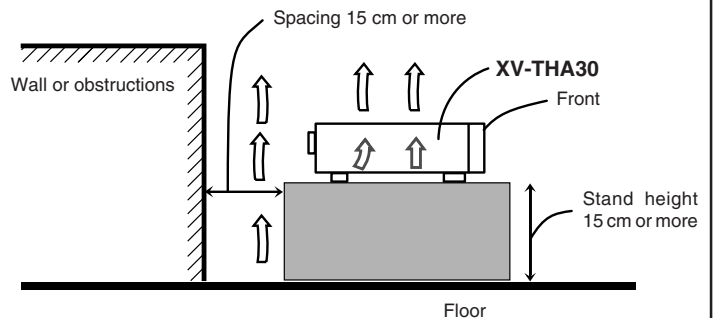

Table of Contents

Parts Identification	2	Basic Disc Operations	28
Center Unit	2	DVD Playback	29
Remote Control	3	Showing the On-Screen Bar	29
Getting Started	5	Selecting the Subtitles	30
Before Installation	5	Selecting the Audio Languages	30
Checking the Supplied Accessories	5	Selecting the Multi-Angle Views	30
Putting Batteries in the Remote Control	5	Checking the Remaining Time	31
Connecting the FM and AM Antennas	6	Disc Menu-Driven Playback	31
Speaker Layout Diagram	7	Moving to a Particular Portion Directly	32
Connecting the Speakers	8	Searching for a Particular Point	32
Connecting Audio/Video Component	9	Repeating Playback	33
TV Preparation	11	■ Repeat Play	33
Changing the Scan Mode	11	■ A-B Repeat	33
Basic DVD Operations	12	Programming the Playing Order of the Chapters	
1 Turn On the Power	12	—Program Play	34
2 Selecting the source	12	DVD Special Effect Playback	36
3 Load a DVD	12	■ Still Picture/Frame-by-Frame Playback	36
4 Start Playback	12	■ Slow Motion Playback	36
5 Adjust the Volume	12	■ Zoom	36
6 Select an Appropriate Progressive Mode	13	VCD/CD Playback	37
7 Activate Surround or DSP Mode	13	Showing the On-Screen Bar	37
8 Stop Playback	13	Checking the Remaining Time	37
Basic VCD/CD Operations	14	Disc Menu-Driven Playback (Only for VCD)	38
1 Turn On the Power	14	Moving to a Particular Portion Directly	38
2 Selecting the source	12	Searching for a Particular Point	38
3 Load a VCD/CD	14	Repeating Playback	39
4 Start Playback	14	■ Repeat Play	39
5 Adjust the Volume	15	■ A-B Repeat	39
6 Activate DSP Mode	15	Programming the Playing Order of the Tracks	
7 Stop Playback	15	—Program Play	40
Basic Tuner Operations	16	Selecting Playback Channel	41
1 Turn On the Power	16	VCD Special Effect Playback	42
2 Select the Band	16	■ Still Picture/Frame-by-Frame Playback	42
3 Adjust the Volume	16	■ Slow Motion Playback	42
4 Tune in to a Station	16	■ Zoom	42
Other Basic Operations	17	MP3 Introduction	43
Enjoying Sounds from the External Component	17	MP3 Playback	44
Selecting an Appropriate Progressive Mode	17	Starting Playback	44
Turning Off the Power with the Timer	17	Operations Using the On-Screen Display	45
Speaker Settings	18	Moving to a Particular Track Directly	46
Setting the Delay Time	18	Repeating Playback	46
Creating Realistic Sound Fields	20	Tuner Operations	47
■ Dolby Digital and DTS Digital Surround	20	Tuning in Stations	47
■ Dolby Surround	20	Using Preset Tuning	48
■ DSP (Digital Signal Processor) Modes	21	Selecting the FM Reception Mode	48
Adjusting Stereo Sound	22	Setting up the DVD Preferences	49
Adjusting Dolby Digital and DTS Digital Surround	23	Setting the Initial Languages	49
Activating Dynamic Range Compression	24	Introducing the DVD Preference (System)	50
Adjusting Dolby Surround	24	Setting the Parental (Rating) Level	52
Adjusting DSP Modes	25	Operating JVC's Components	54
Disc Introduction—DVD/VCD/CD	27	Operating Other Manufacturers' TV	55
		Maintenance	56
		Troubleshooting	57
		Specifications	58

Parts Identification

Center Unit

Front Panel

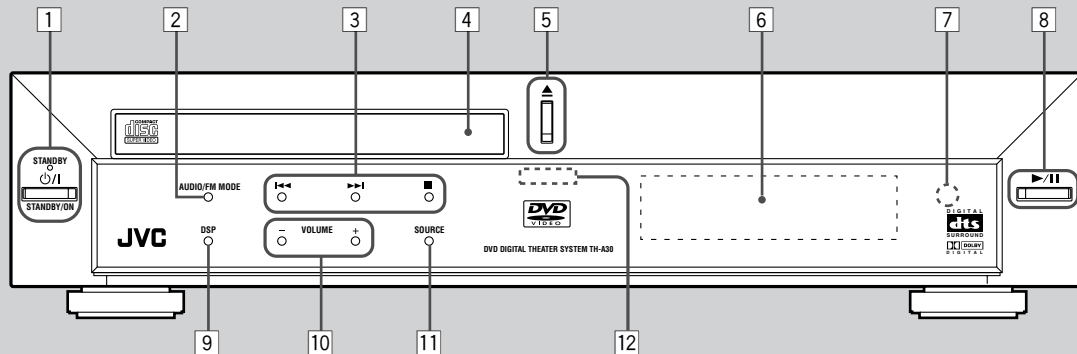

See pages in the parentheses for details.

Front Panel

- | | |
|------------------------------------------------------------------------------------------------------------------------------------------------------------------------------------------------------------------------------------------------------------------------------------------------------------------------------------------------------------------------------------------------------------------------------------------------------------------------------------------------------------------------------------------------------------------------------------------------------------------------------------------------|--------------------------------------------------------------------------------------------------------------------------------------------------------------------------------------------------------------------------------------------------------------------------------------------------------------------------------------------------------------------------------------------------------------------------------------------------------------------------------------------------------|
| <ul style="list-style-type: none"> 1 STANDBY/ON \odot/I button and STANDBY lamp (12 – 16) 2 AUDIO/FM MODE button (30, 41, 48) 3 Multi operation buttons <ul style="list-style-type: none"> • \lll, \ggg, and ■ 4 Disc tray (12, 14) 5 \blacktriangle (open/close) button (12 – 15, 35, 40, 44) <ul style="list-style-type: none"> • Pressing this button also turns on the power and changes the source to the DVD player. 6 Display window | <ul style="list-style-type: none"> 7 Remote sensor 8 $\blacktriangleright/\text{II}$ (play/pause) button (12, 13, 14, 15, 28, 44) <ul style="list-style-type: none"> • Pressing this button also turns on the power and changes the source to the DVD player. 9 DSP button (13, 15, 22, 25) 10 VOLUME + and – buttons (12, 15, 16) 11 SOURCE button (16, 17, 47, 48) 12 Illumination lamp (12 – 16) |
|------------------------------------------------------------------------------------------------------------------------------------------------------------------------------------------------------------------------------------------------------------------------------------------------------------------------------------------------------------------------------------------------------------------------------------------------------------------------------------------------------------------------------------------------------------------------------------------------------------------------------------------------|--------------------------------------------------------------------------------------------------------------------------------------------------------------------------------------------------------------------------------------------------------------------------------------------------------------------------------------------------------------------------------------------------------------------------------------------------------------------------------------------------------|

Display Window

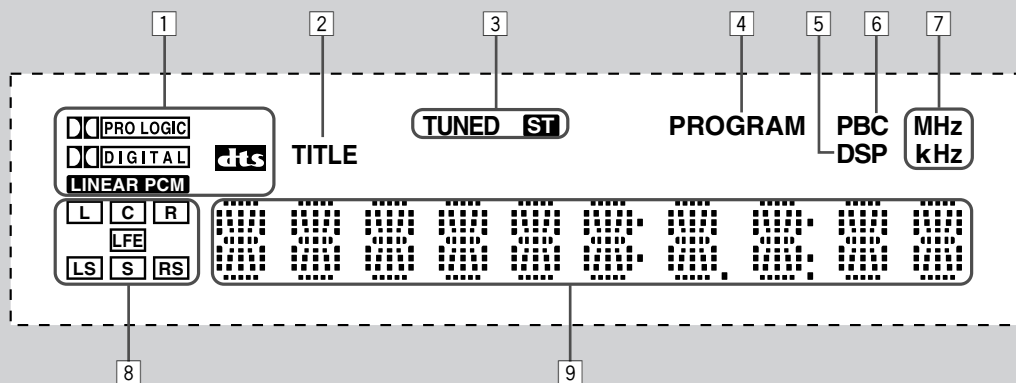

See pages in the parentheses for details.

Display Window

- | | |
|----------------------------------------------------------------------------------------------------------------------------------------------------------------------------------------------------------------------------------------------------------------------------------------------------------------------------------------------------------------------------------------------------------------------------|-------------------------------------------------------------------------------------------------------------------------------------------------------------------------------------------------------------------------------------------------------------------------------------------------------------------------------------------------------------------------------------------------------------------------------------------------------------------------|
| <ul style="list-style-type: none"> 1 Sound signal indicators (13, 15, 17, 20) <ul style="list-style-type: none"> • PRO LOGIC, DOLBY DIGITAL, DTS, and LINEAR PCM 2 TITLE indicator (28) 3 Tuner mode indicators (16, 47, 48) <ul style="list-style-type: none"> • TUNED and ST (stereo) 4 PROGRAM indicator (34, 40, 48) | <ul style="list-style-type: none"> 5 DSP indicator (21, 25) 6 PBC (Play Back Control) indicator (37, 38) 7 Frequency unit indicators <ul style="list-style-type: none"> • MHz (for FM station) and kHz (for AM station) 8 Audio channel indicators <ul style="list-style-type: none"> • Indicates audio channels currently being played back. 9 Main display |
|----------------------------------------------------------------------------------------------------------------------------------------------------------------------------------------------------------------------------------------------------------------------------------------------------------------------------------------------------------------------------------------------------------------------------|-------------------------------------------------------------------------------------------------------------------------------------------------------------------------------------------------------------------------------------------------------------------------------------------------------------------------------------------------------------------------------------------------------------------------------------------------------------------------|

Remote Control

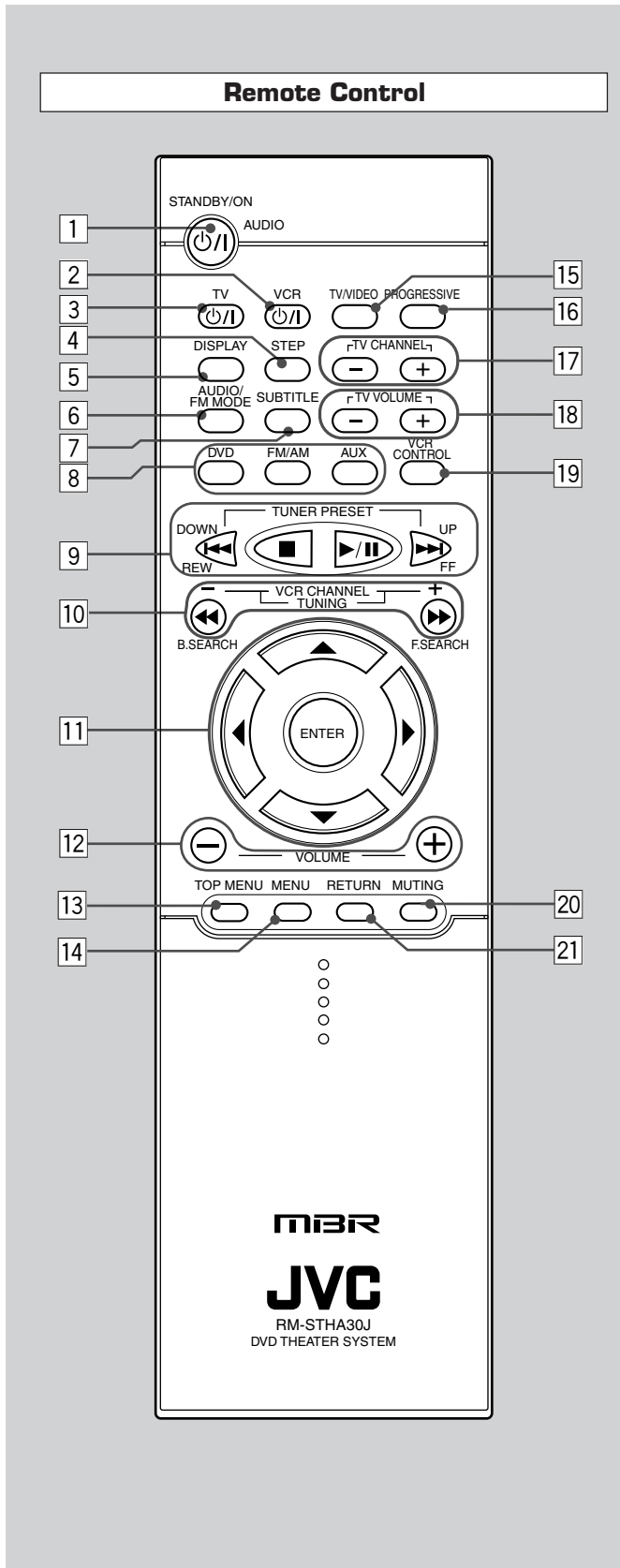

See pages in the parentheses for details.

Remote Control

- 1 STANDBY/ON \odot/I AUDIO button (12 – 16)
 - 2 VCR \odot/I button (54)
 - 3 TV \odot/I button (12, 14, 54, 55)
 - 4 STEP button (36, 42, 54)
 - 5 DISPLAY button (29, 37)
 - 6 AUDIO/FM MODE button (30, 41, 48)
 - 7 SUBTITLE button (30)
 - 8 Source selecting buttons (12, 14, 16, 17, 24, 47)
 - DVD, FM/AM, AUX
 - Pressing one of these buttons also turns on the power.
 - 9 \lll , \blacksquare , \ggg , and II buttons
 TUNER PRESET UP and DOWN buttons (48)
 FF (Fast-forward) and REW (Rewind) buttons
 - 10 VCR CHANNEL + and – buttons (54)
 TUNING + and – buttons (16, 47)
 \ggg F. (Forward) SEARCH and \lll B. (Back) SEARCH buttons
 - 11 Menu operation buttons
 - \blacktriangleright , \blacktriangleleft , \blacktriangleup , and \blacktriangledown buttons
 - ENTER button
 - 12 VOLUME + and – buttons (12, 15, 16)
 - 13 TOP MENU button (31)
 - 14 MENU button (31, 38)
 - 15 TV/VIDEO button (12, 14, 54, 55)
 - 16 PROGRESSIVE button (11, 13, 17)
 - 17 TV CHANNEL + and – buttons (54, 55)
 - 18 TV VOLUME + and – buttons (54, 55)
 - 19 VCR CONTROL button (54)
- IMPORTANT:**

If you press VCR CONTROL, this remote control will work ONLY for the JVC's VCR. When you want to operate the system again, press DVD or FM/AM.
- 20 MUTING button (12, 15)
 - 21 RETURN button (38, 50, 51)

Inside the Cover

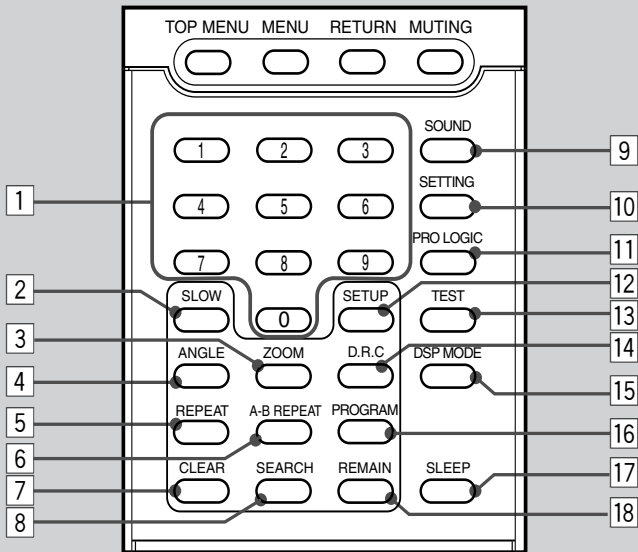

Inside the Cover

- 1 Number buttons (31, 38, 46, 54, 55)
- 2 SLOW button (36, 42)
- 3 ZOOM button (36, 42)
- 4 ANGLE button (30)
- 5 REPEAT button (33, 39, 46)
- 6 A-B REPEAT button (33, 39)
- 7 CLEAR button (32, 38, 41)
- 8 SEARCH button (32, 38, 46)
- 9 SOUND button (22 – 26)
- 10 SETTING button (18, 19)
- 11 PRO LOGIC button (17, 19, 22, 24)
- 12 SETUP button (50 – 53)
- 13 TEST button (21)
- 14 D.R.C button (24)
- 15 DSP MODE button (13, 15, 22, 25)
- 16 PROGRAM button (34, 35, 40, 48)
- 17 SLEEP button (17)
- 18 REMAIN button (31, 37)

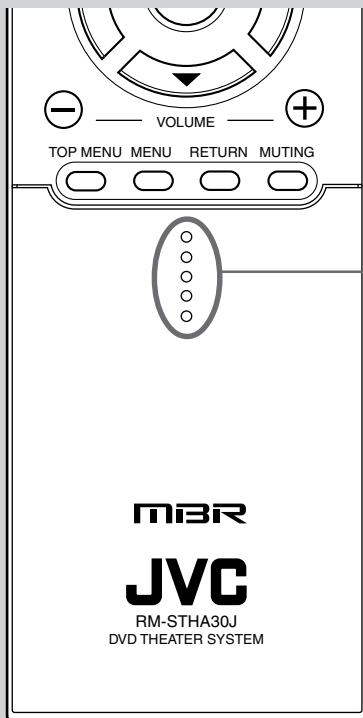

To open the cover of the remote control, push here then slide downward.

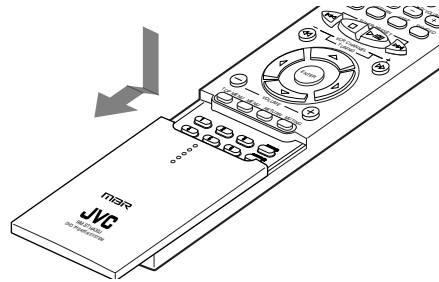

Getting Started

Before Installation

General Precautions

- DO NOT insert any metal object into the center unit.
- DO NOT disassemble the center unit or remove screws, covers, or cabinet.
- DO NOT expose the center unit to rain or moisture.

Locations

- Install the center unit in a location that is level and protected from moisture.
- The temperature around the center unit must be between 5°C and 35°C (41°F and 95°F).
- Make sure there is good ventilation around the center unit. Poor ventilation could cause overheating and damage the center unit.

Handling the center unit

- DO NOT touch the power cord with wet hands.
- DO NOT pull on the power cord to unplug the cord. When unplugging the cord, always grasp the plug so as not to damage the cord.
- Keep the power cord away from the connecting cords and the antenna. The power cord may cause noise or screen interference. It is recommended to use a coaxial cable for antenna connection, since it is well-shielded against interference.
- When a power failure occurs, or when you unplug the power cord, the preset settings such as preset FM/AM channels and sound adjustments may be erased in a few days.

Checking the Supplied Accessories

Check to be sure you have all of the following supplied accessories. The number in the parentheses indicates the quantity of the pieces supplied.

- Remote Control (1)
- Batteries (2)
- AM loop antenna (1)
- FM antenna (1)
- Video cord (1)

If anything is missing, contact your dealer immediately.

Putting Batteries in the Remote Control

Before using the remote control, put two supplied batteries first.

- When using the remote control, aim the remote control directly at the remote sensor on the center unit.

1. On the back of the remote control, remove the battery cover.

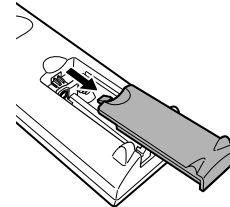

2. Insert batteries. Make sure to match the polarity: (+) to (+) and (-) to (-).

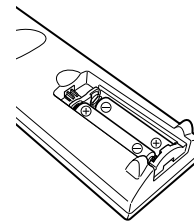

3. Replace the cover.

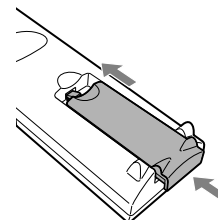

If the range or effectiveness of the remote control decreases, replace the batteries. Use two UM-4“AAA”/IEC “R03” type dry-cell batteries.

CAUTION:

Follow these precautions to avoid leaking or cracking cells:

- Place batteries in the remote control so they match the polarity: (+) to (+) and (-) to (-).
- Use the correct type of batteries. Batteries that look similar may differ in voltage.
- Always replace both batteries at the same time.
- Do not expose batteries to heat or flame.

Connecting the FM and AM Antennas

If AM reception is poor, connect single vinyl-covered wire (not supplied).

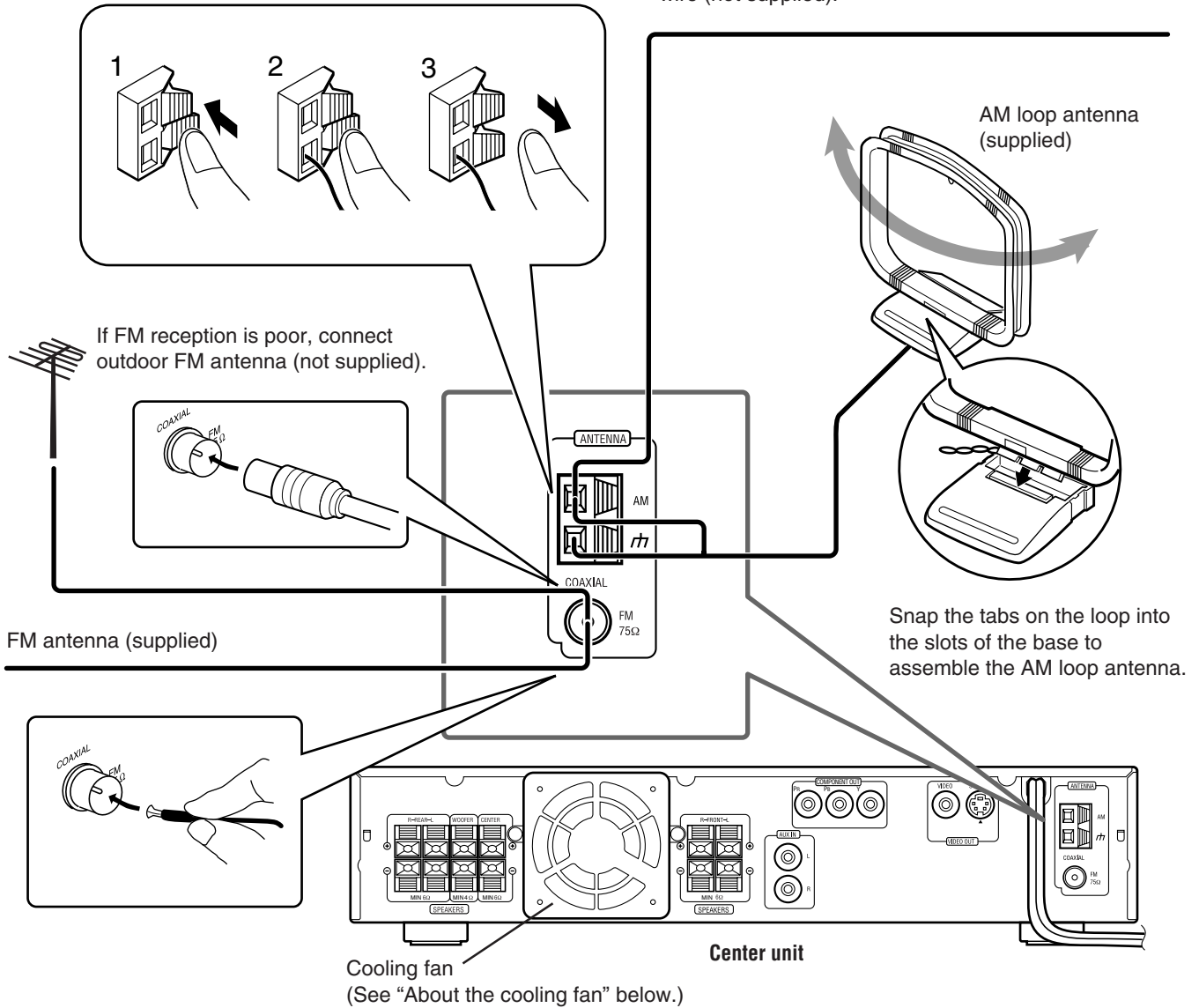

FM antenna connection

Connect the supplied FM antenna to the FM 75 Ω COAXIAL terminal as temporary measure.

Extend the supplied FM antenna horizontally.

- If reception is poor, connect an outdoor antenna. Before attaching a 75 Ω coaxial cable (with a standard type connector), disconnect the supplied FM antenna.

AM antenna connection

Connect the supplied AM loop antenna to the AM and π terminals. Turn the loop until you have the best reception.

- If reception is poor, connect an outdoor single vinyl-covered wire to the AM terminal. (Keep the AM loop antenna connected.)

Note:

If the AM loop antenna wire is covered with vinyl, remove the vinyl by twisting it as shown in the diagram.



About the cooling fan

A cooling fan is mounted on the rear panel of the center unit to prevent abnormal temperature inside the center unit, thus assuring normal operation of the unit. The cooling fan automatically starts rotating to supply external cool air to the inside of the center unit when the internal temperature goes up.

For safety, observe the following carefully.

- Make sure there is good ventilation around the center unit. Poor ventilation could overheat and damage the center unit.
- DO NOT block the cooling fan and the ventilation openings or holes. (If they are blocked by a newspaper or cloth, etc., the heat may not be able to get out.)
- DO NOT touch the speaker cords to the cooling fan.

Getting Started

Speaker Layout Diagram

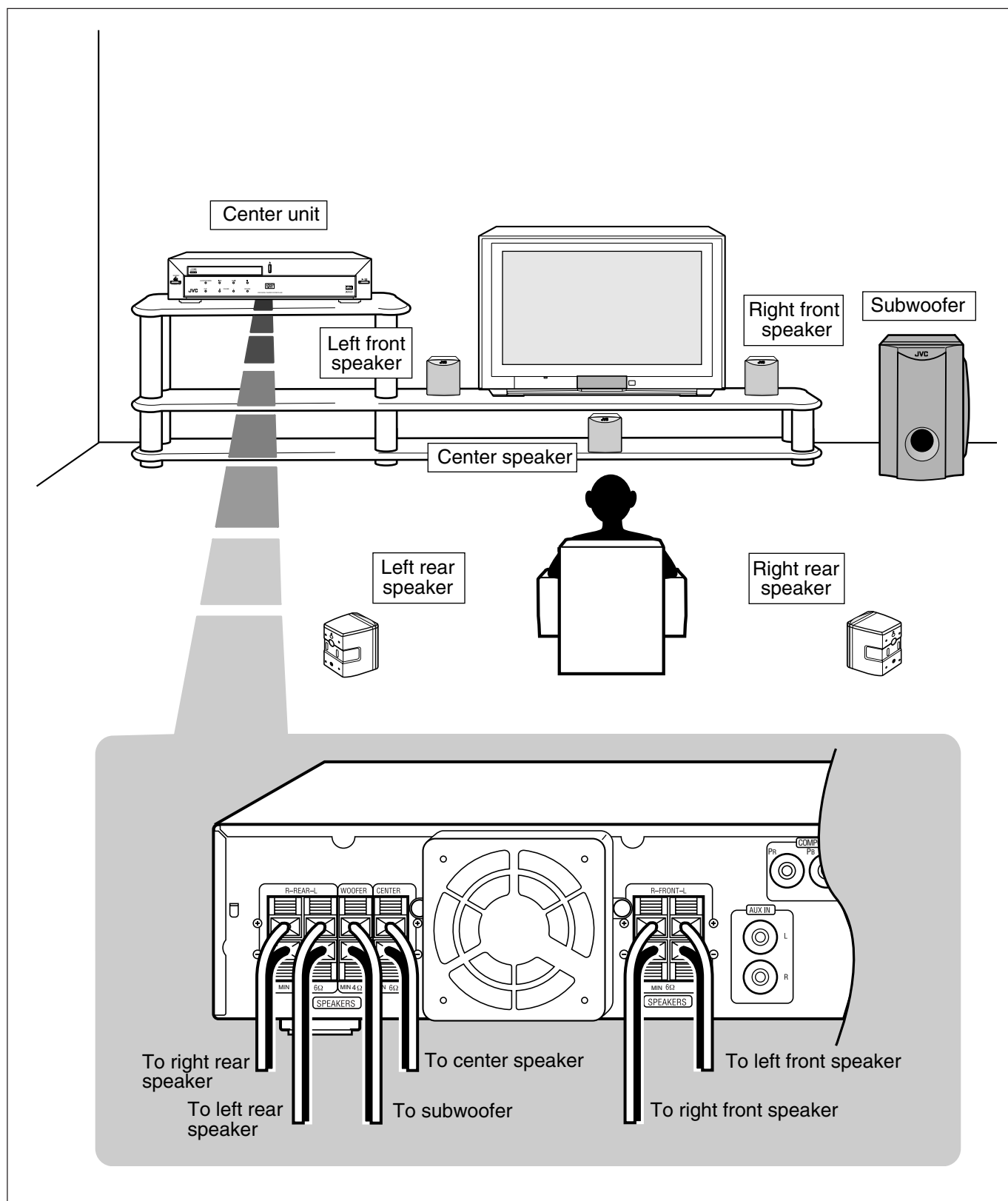

Connecting the Speakers

Connect the satellite speakers and subwoofer to the terminals on the rear panel using speaker cords supplied.

Labels are attached to the speaker cords to indicate the terminals to be connected.

- Connect the red cord to the red (+) terminal, and the black cord to the black (-) terminal respectively.

CAUTION:

Use speakers with the SPEAKER IMPEDANCE indicated by the speaker terminals.

Connecting speaker cords to the terminals

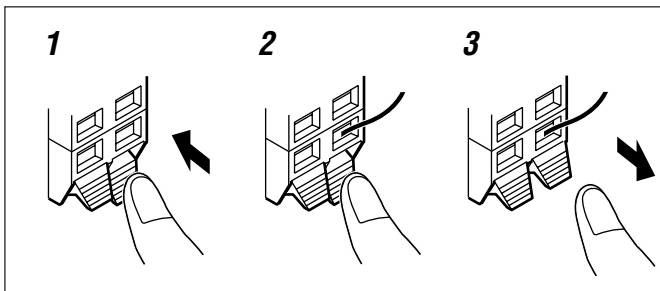

1 Press and hold the terminal clamp.

2 Insert the speaker cord.

3 Release the finger from the clamp.

Notes:

- If the speaker cord is covered with vinyl, remove the vinyl by twisting it as shown in the diagram.
- Make sure the core wire of speaker cords do not expose to out of the terminals. This could cause short-circuit.

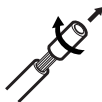

When setting the speakers

To obtain the best possible sound from this system, you need to place all the speakers except the subwoofer at the same distance from the listening position with each front faced toward the listener. Since bass sound is non-directional, you can place a subwoofer wherever you like. Normally place it in front of you.

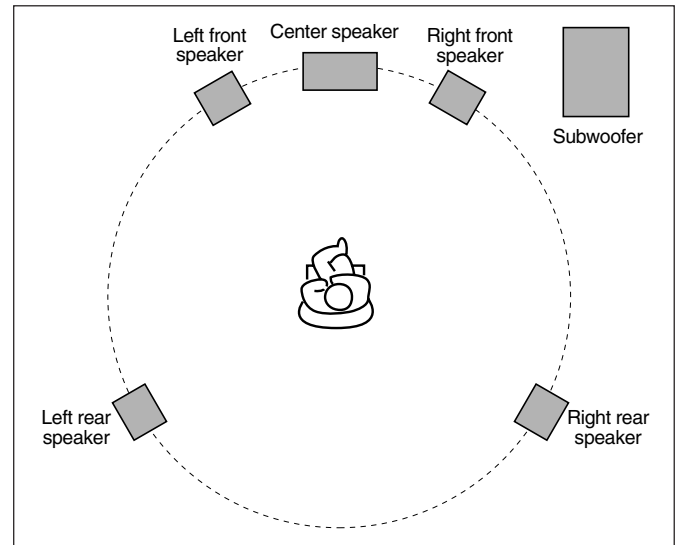

If your speakers cannot be placed at the same distance from the listening position

You can adjust the delay time of the center speaker and rear speakers. For in-depth information about adjusting the delay time, see "Setting the Delay Time" on page 18 and 19.

Note:

You can change the phase of subwoofer sounds by connecting the speaker cords to the terminals inversely—the red cord to the black terminal, and the black cord to the red terminal. You may get the more effective bass sounds by changing the phase.

CAUTION:

- When attaching the satellite speakers on the wall, have them attached to the wall by a qualified person. DO NOT attach the satellite speakers on the wall by yourself to avoid an unexpected damage of their falling from the wall, caused by incorrect attachment or weakness in the wall.
- Care is required in selecting a location for attaching speakers to the wall. Injury to personnel, or damage to equipment, may result if the speakers are attached in a location which interferes with daily activities.

Getting Started

Connecting Audio/Video Component

Turn the power off to all components before connections.

Audio component connection

Connect another component to the center unit with the audio cords.
Use the cords supplied with another component or purchase them at an electric appliance store.

Audio cord (not supplied)

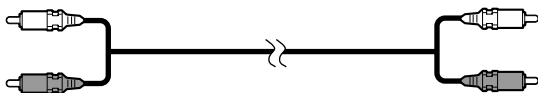

Illustrations of the input/output terminals below are typical examples.
When you connect another component, refer also to its manuals since the terminal name actually printed on the rear vary among the components.

If you connect a sound-enhancing device such as a graphic equalizer between the source component and the center unit, the sound output through this system may be distorted.

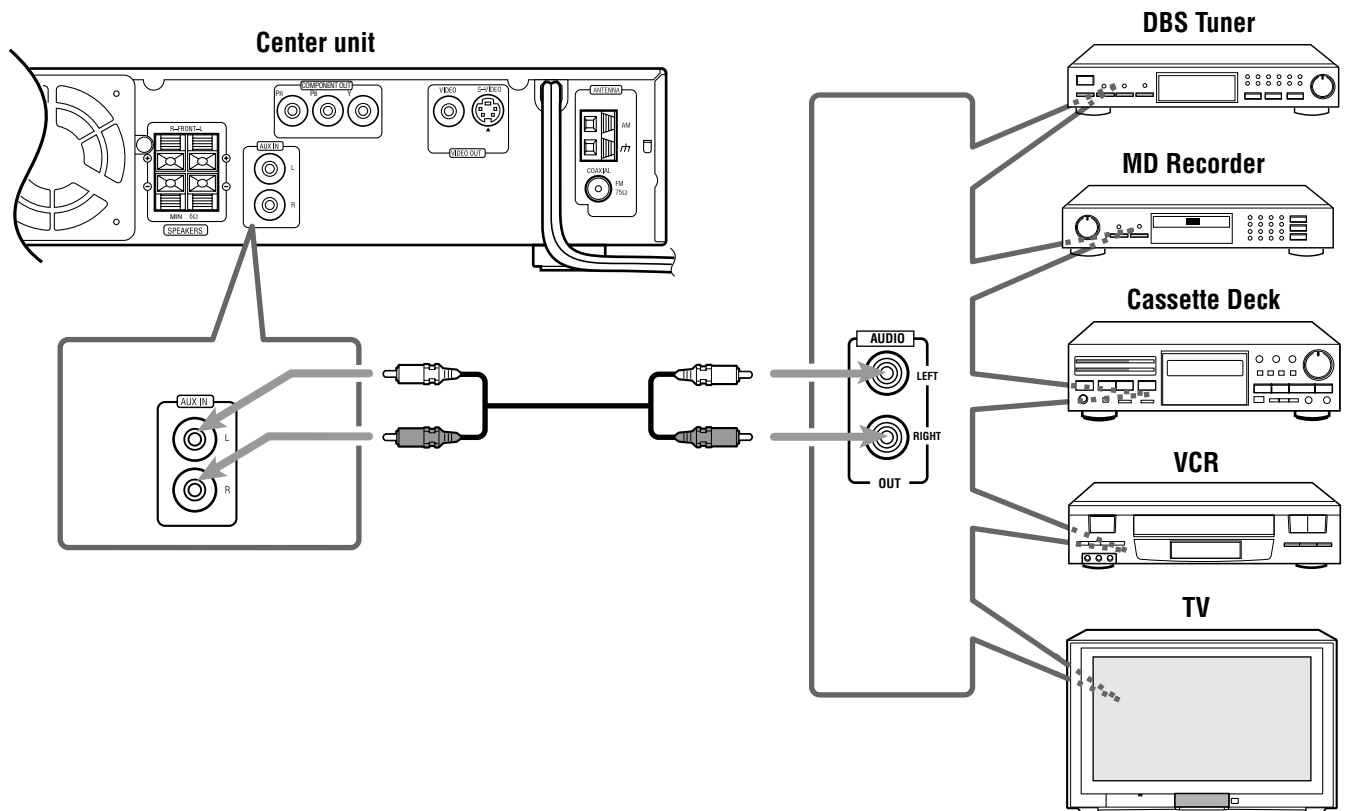

TV connection

The S-video cord and the component video cord are not supplied with this system.
Use the cords supplied with another components or purchase them at an electric appliance store.

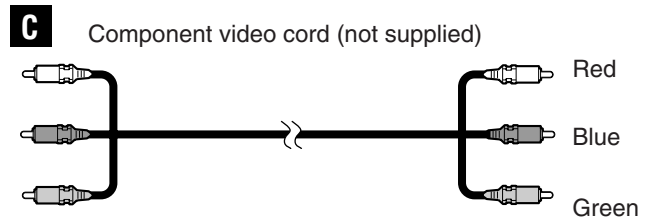
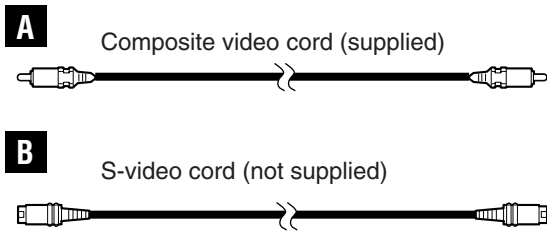

You can select one of three connection types—**A**, **B**, and **C**.

- If your TV has S-video (Y/C-separation) and/or component video (Y, Pr, Pb) jacks, connect them using an S-video cord (not supplied) **B** and/or component video cord (not supplied) **C**. By using these jacks, you can get a better picture quality—in the order : Component video > S-video > Composite video.
- If your TV supports the progressive video input, you can enjoy a high quality picture by making the progressive scan mode active.

Illustrations below are typical examples.

When you connect the TV, refer also to its manual since the terminal names actually printed on the rear vary among the components.

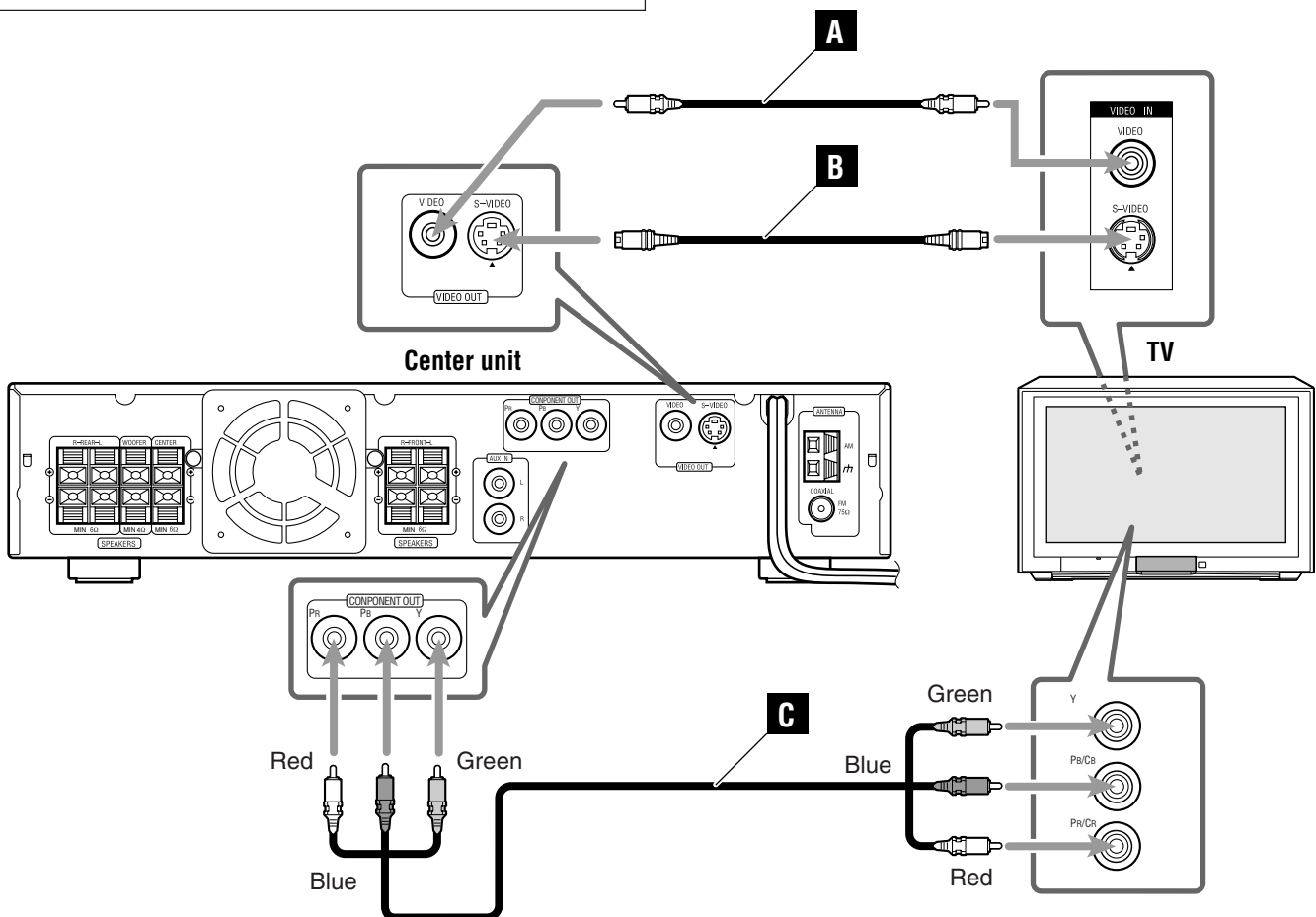

Now, you can plug the power cord of the center unit into the AC outlet.

Note:

Keep the power cord away from the connecting cords and the antenna cables. The power cord may cause noise or screen interference.

TV Preparation

This system supports the progressive scanning system (480p*) as well as the conventional interlaced scanning system (480i*).

If your TV equipped with component video jacks supports the progressive video input, you can enjoy a high quality picture by activating the progressive scanning mode.

- Refer also to the instruction manuals supplied with your TV.
- If your TV equipped with component video jacks does not support the progressive video input, do not change the scanning mode to the progressive scanning mode (P-SCAN MODE.)

* 480p and 480i indicate the number of scanning lines and scanning format of a video signal.

- 480p indicates 480 scanning lines with progressive format.
- 480i indicates 480 scanning lines with interlaced format.

About scanning system

The conventional scanning method to display video signals on the TV screen is called "Interlaced scanning." With this method, only half of the horizontal lines (called a "field") are displayed at a time. So two fields complete a single picture (frame); i.e., the first field, containing all the odd-numbered lines, is followed by the second field, containing all the even-numbered lines.

On the other hand, the Progressive scanning system scans all horizontal lines at a time, so you can double the number of scanning lines displayed at a time, resulting in a flicker-free, high-density picture.

To enjoy the progressive scanned picture, a monitor (or TV or projector) connected to the system must support the progressive video inputs.

Depending on the material source format, DVD video can be classified into two types; film source and video source (note that some DVD video contain both film source and video source). Film sources are recorded as 24-frame-per-second data, while (NTSC) video sources are recorded as 30-frame-per-second (60-field-per-second interlaced).

When this system plays back a film source data, uninterlaced progressive output signals are created using the original data. When a video source is played back, the unit interleaves lines between the interlaced lines to create the pseudo uninterlaced picture and outputs as the progressive signals.

Changing the Scan Mode

You can select the scanning mode if your TV equipped with component video jacks supports the progressive video input.

From the remote control ONLY:

1 Press DVD.

You can change the scan mode only when DVD is selected as the source and playback stops.

If a disc is no loaded, go to step 3.



2 Press ■.

Playback stops.

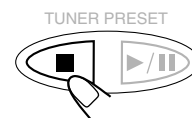

3 Press and hold PROGRESSIVE for a while.

- Each time you press and hold the button, the scan mode alternates between "I-SCAN MODE" and "P-SCAN MODE".



I (Interlace)-SCAN MODE

: Select this if your TV equipped with component video jacks does not support the progressive video input (conventional TV).

P (Progressive)-SCAN MODE

: Select this if your TV equipped with component video jacks supports the progressive video input.

Notes

- Some progressive TVs and High-Definition TVs are not fully compatible with this system, resulting in the unnatural picture when playing back a DVD in the progressive scanning mode. In such a case, change the scanning mode to "I-SCAN MODE" To check the compatibility of your TV, contact your local JVC customer service center.
- All JVC progressive TVs and High-Definition TVs are fully compatible with this system.

To select an appropriate progressive mode for playback pictures, see "Selecting an Appropriate Progressive Mode" on page 17.

Basic DVD Operations

This manual mainly explains operations using the buttons on the remote control. You can also use the buttons on the center unit if they have the similar names (or marks) as those on the remote control.

If operations using the center unit are different from those using the remote control, they are then explained.

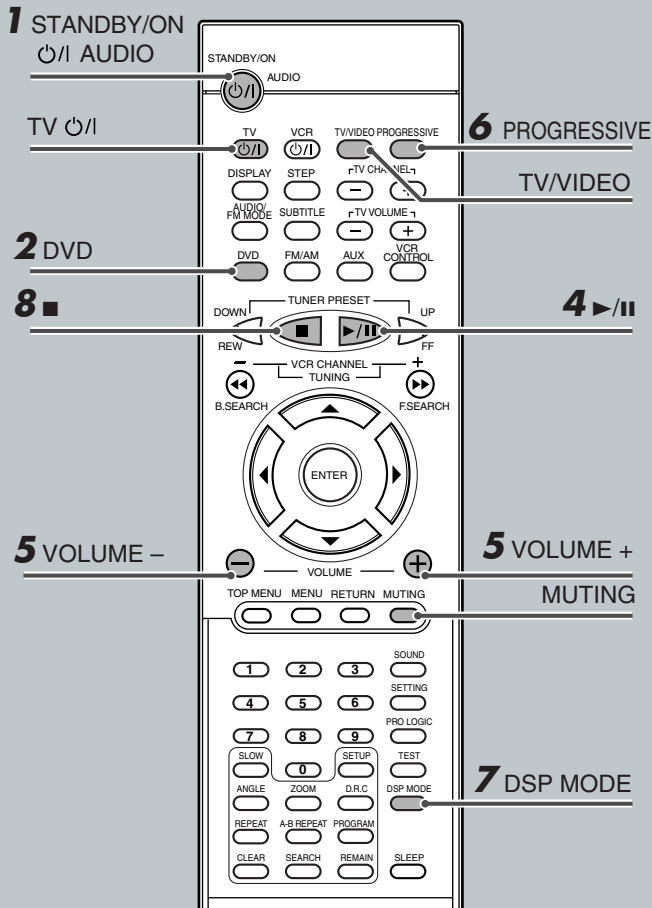

For in-depth information about DVD operations, see pages 27 to 36.

1 Turn On the Power

Before turning on the system, turn on your TV and select the correct video input. (See the manual supplied with your TV.)

- When you use a JVC's TV, you can turn on your TV by pressing TV on the remote control, and select the video input by pressing TV/VIDEO. (If your TV is not a JVC's, see "Operating Other Manufacturers' TV" on page 55.)
- For changing the OSD messages—the information on the TV screen—into the desired language, see "Setting the Initial Languages" on pages 49 and 50.

Press STANDBY/ON AUDIO (or STANDBY/ON on the front panel).

The STANDBY lamp goes off and the illumination lamp on the center unit lights up. The source indication selected previously appears on the display.



2 Select the Source

Press DVD.

The source changes to DVD.



3 Load a DVD

On the front panel ONLY:

Press to open the disc tray, then place a DVD correctly with its label side up.

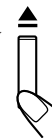
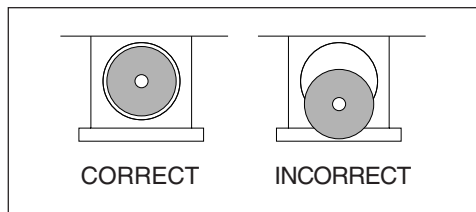

4 Start Playback

Press .

The disc tray closes. "LOADING" appears for a while.

- You can also start playback by closing the disc tray using on the front panel.

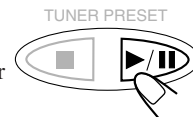

5 Adjust the Volume

To increase the volume, press and hold VOLUME +.

To decrease the volume, press and hold VOLUME -.



CAUTION:

Always set the volume to the minimum before starting any source. If the volume is set at its high level, the sudden blast of sound energy can permanently damage your hearing and/or ruin your speakers.

Notes:

- By pressing VOLUME + or - repeatedly, you can adjust the volume level step by step.
- The volume level can be adjusted within 51 steps—"MIN (minimum)," 01 to 49, and "MAX (maximum)."

To turn off the sounds temporarily

From the remote control ONLY:

Press MUTING.

To restore the sound, press MUTING again.

- Pressing VOLUME + or - also restores the sound.



Basic DVD Operations

6 Select an Appropriate Progressive Mode

You can select the progressive mode according to the picture type (film or video source).

Press **PROGRESSIVE** repeatedly until the progressive mode you want appears.

- Each time you press the button, the progressive mode changes as follows:

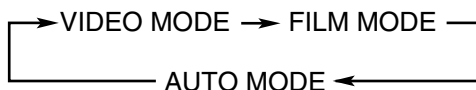

Notes:

- This mode is available only when progressive scanning mode is selected.
- For in-depth information about each progressive mode, see page 17.

7 Activate Surround or DSP Mode

You can enjoy two kinds of surround—Digital Multichannel Surround (Dolby Digital and DTS Digital Surround) and DSP modes.

Digital Multichannel Surround—Dolby Digital and DTS Digital Surround

Dolby Digital or DTS Digital Surround takes effect only when you enjoy a disc encoded with its signals—the DOLBY DIGITAL or DTS indicator lights up on the display.



Sound signal indicators on the display

To activate Dolby Digital or DTS Digital Surround

When a disc encoded with the Dolby Digital or DTS Digital Surround is loaded, the system detects it and starts playing the disc automatically with Multichannel Surround activated.

- For in-depth information about surround modes, see “Creating Realistic Sound Fields” on pages 20 and 25 .

DSP modes—THEATER, HALL, LIVE CLUB, DANCE CLUB

DSP modes take effect only when you enjoy a disc recorded using Linear PCM—the LINEAR PCM indicator lights up on the display.



Sound signal indicators on the display

To activate DSP modes

Press **DSP MODE** (or **DSP** on the front panel).

The DSP indicator lights up and the current DSP mode appears on the display for a while.

- Each time you press the button, DSP mode changes as follows:

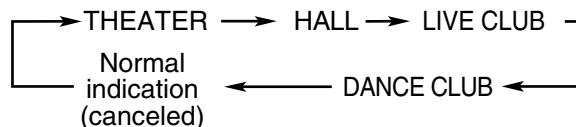

- For in-depth information about DSP modes, see “Creating Realistic Sound Fields” on pages 21, 25, and 26.



Note:

Before activating surround or DSP mode, adjust the speaker setting to bring out the best performance from this system.

For in-depth information about adjusting the speaker setting, see “Speaker Settings” on pages 18 and 19.

8 Stop Playback

Press **■** twice.

Playback stops completely and “DVD” appears on the display. (The DVD player goes on working for 3 minutes after playback stops.)

- This system can memorize the end point even when you press **■** once. When you start playback again by pressing **▶/II**, playback begins from where it has been stopped—Resume play.

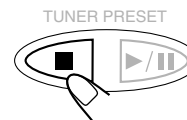

To remove the loaded disc

Press **▲**.

“OPEN” appears on the display and the disc tray comes out.

To close the disc tray, press **▲** again.

- If you do not press the button, the disc tray closes automatically after 3 minutes.

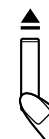

To turn off the power (into standby)

Press **STANDBY/ON** **⏻/I** **AUDIO** (or **STANDBY/ON** **⏻/I** on the front panel).

The illumination lamp goes off and the STANDBY lamp lights up.

- If you press **STANDBY/ON** **⏻/I** **AUDIO** (or **STANDBY/ON** **⏻/I** on the front panel) while the disc tray is kept open, the disc tray closes automatically, then the system is turned off.
- A small amount of power is consumed even in standby mode. To turn the power off completely, unplug the AC power cord.



Basic VCD/CD Operations

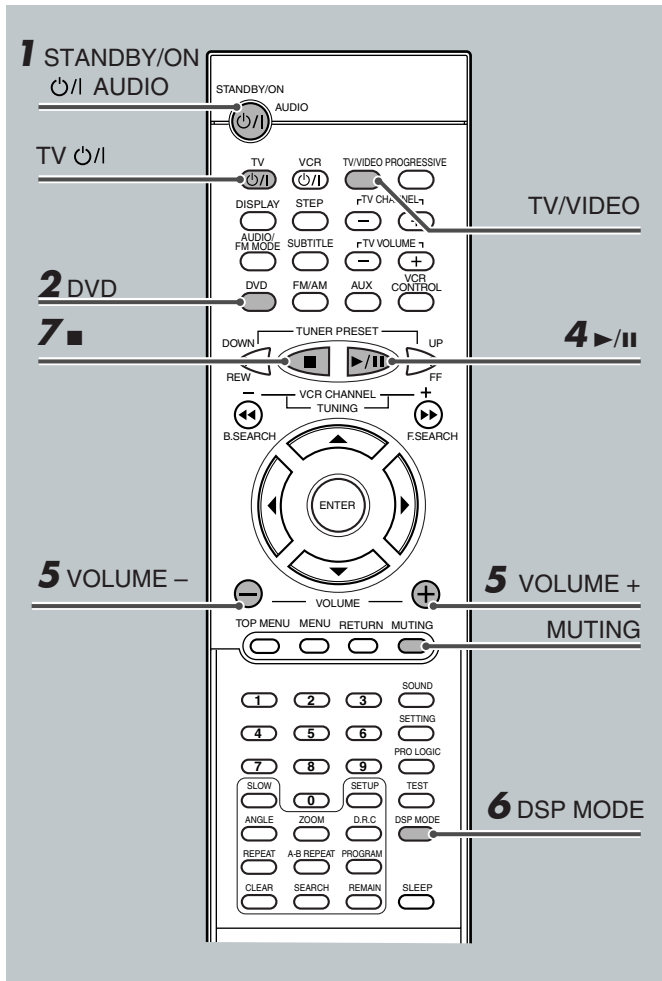

- SVCD can be operated by using the VCD operation procedure.
- For in-depth information about VCD/CD operations, see pages 27, 28, and 37 to 42.

1 Turn On the Power

Before turning on the system, turn on your TV if necessary and select the correct video input. (See the manual supplied with your TV.)

- When you use a JVC's TV, you can turn on your TV by pressing TV \odot/I on the remote control, and select the video input by pressing TV/VIDEO. (If your TV is not a JVC's, see "Operating Other Manufacturers' TV" on page 55.)
- For changing the OSD messages—the information on the TV screen—into the desired language, see "Setting the Initial Languages" on pages 49 and 50.

Press STANDBY/ON \odot/I AUDIO (or STANDBY/ON \odot/I on the front panel).

The STANDBY lamp goes off and the illumination lamp on the center unit lights up. The source indication selected previously appears on the display.



2 Select the Source

Press DVD.



3 Load a VCD/CD

On the front panel ONLY:

Press \blacktriangle to open the disc tray, then place a disc correctly with its label side up.

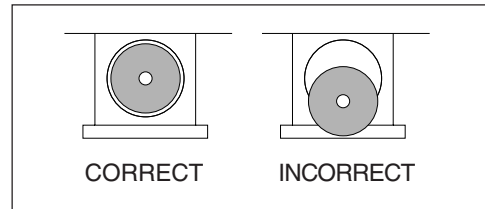

- When using a CD single (8 cm), place it on the inner circle of the disc tray.
- Continued use of irregular shape CDs (heart-shape, octagonal, etc.) can damage the center unit.

4 Start Playback

Press $\blacktriangleright/\text{II}$.

The disc tray closes. "LOADING" appears for a while.

- You can also start playback by closing the disc tray using \blacktriangle on the front panel.

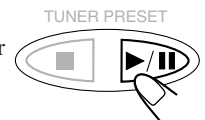

Basic VCD/CD Operations

5 Adjust the Volume

To increase the volume, press and hold VOLUME +.
To decrease the volume, press and hold VOLUME –.

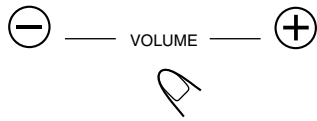

CAUTION:

Always set the volume to the minimum before starting any source. If the volume is set at its high level, the sudden blast of sound energy can permanently damage your hearing and/or ruin your speakers.

Notes:

- By pressing VOLUME + or – repeatedly, you can adjust the volume level step by step.
- The volume level can be adjusted within 51 steps—“MIN (minimum),” 01 to 49, and “MAX (maximum).”

To turn off the sounds temporarily

From the remote control ONLY:

Press MUTING.



To restore the sound, press MUTING again.

- Pressing VOLUME + or – also restores the sound.

6 Activate DSP Mode

You can enjoy DSP modes.

DSP modes—HALL, THEATER, LIVE CLUB, DANCE CLUB

DSP modes take effect only when you enjoy a disc recorded using Linear PCM—the LINEAR PCM indicator lights up on the display.

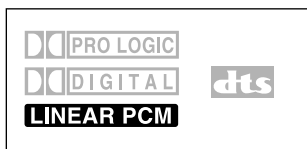

Sound signal indicators on the display

To activate DSP modes

Press DSP MODE (or DSP on the front panel).

The DSP indicator lights up and the current DSP mode appears on the display for a while.



- Each time you press the button, DSP mode changes as follows:

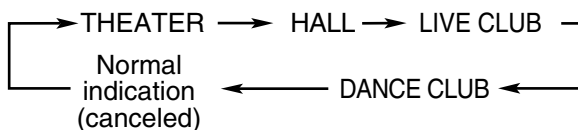

— For in-depth information about DSP modes, see “Creating Realistic Sound Fields” on pages 21, 25, and 26.

Note:

Before activating DSP mode, adjust the speaker setting to bring out the best performance from this system.
For in-depth information about adjusting the speaker setting, see “Speaker Settings” on pages 18 and 19.

7 Stop Playback

Press ■ twice.

Playback stops completely and “VCD” or “CD” appears on the display. (The DVD player goes on working for 3 minutes after playback stops.)



- This system can memorize the end point even when you press ■ once. When you start playback again by pressing ►/||, playback begins from where it has been stopped—Resume play.

To remove the loaded disc

Press ▲.

“OPEN” appears on the display and the disc tray comes out.



To close the disc tray, press ▲ again.

- If you do not press the button, the disc tray closes automatically after 3 minutes.

To turn off the power (into standby)

Press STANDBY/ON ⏻/|| AUDIO (or STANDBY/ON ⏻/|| on the front panel).

The illumination lamp goes off and the STANDBY lamp lights up.



- If you press STANDBY/ON ⏻/|| AUDIO (or STANDBY/ON ⏻/|| on the front panel) while the disc tray is kept open, the disc tray closes automatically, then the system is turned off.
- A small amount of power is consumed even in standby mode. To turn the power off completely, unplug the AC power cord.

Basic Tuner Operations

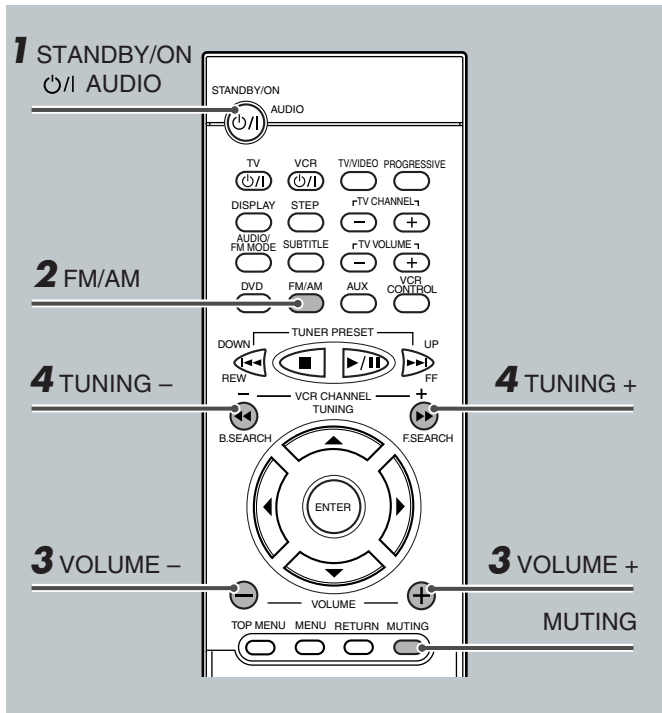

For in-depth information about tuner operations, see “Tuner Operations” on pages 47 and 48.

1 Turn On the Power

Press **STANDBY/ON** **AUDIO** (or **STANDBY/ON** on the front panel). The **STANDBY** lamp goes off and the illumination lamp lights up on the center unit. The source indication selected previously appears on the display.



2 Select the Band

From the remote control:
Press **FM/AM**.
The last received station of the selected band is tuned in.
• Each time you press the button, the band alternates between FM and AM.



On the front panel:
Press **SOURCE** repeatedly until the desired band (FM or AM) appears on the display.
The last received station of the selected band is tuned in.
• Each time you press the button, the source changes as follows:

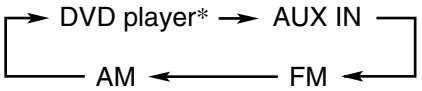

* “WAIT” appears on the display.

3 Adjust the Volume

To increase the volume, press and hold **VOLUME +**.
To decrease the volume, press and hold **VOLUME -**.



CAUTION:
Always set the volume to the minimum before starting any source. If the volume is set at its high level, the sudden blast of sound energy can permanently damage your hearing and/or ruin your speakers.

- Notes:**
- By pressing **VOLUME +** or **-** repeatedly, you can adjust the volume level step by step.
 - The volume level can be adjusted within 51 steps—“MIN (minimum),” 01 to 49, and “MAX (maximum).”
 - You can turn off the sounds temporarily by pressing **MUTING**.

4 Tune in to a Station

From the remote control:
Press and hold **TUNING +** or **-** until the station frequency starts changing continuously on the display. The system starts searching for a station.

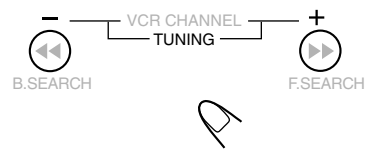

- On the front panel:**
- 1) Press **MANUAL** so that “MANUAL” appears on the display.
 - 2) Press and hold **TUNING +** or **-** until the station frequency starts changing continuously on the display. The system starts searching for a station.

- Notes:**
- When a station of sufficient signal strength is tuned in, the system stops searching, and the **TUNED** indicator lights up on the display.
 - When an FM stereo program is received, the **ST** indicator also lights up.
 - When you press the button repeatedly, the frequency changes step by step.

To turn off the power (into standby)
Press **STANDBY/ON** **AUDIO** (or **STANDBY/ON** on the front panel) again. The illumination lamp goes off and the **STANDBY** lamp lights up.
• A small amount of power is consumed even in standby mode. To turn the power off completely, unplug the AC power cord.



Other Basic Operations

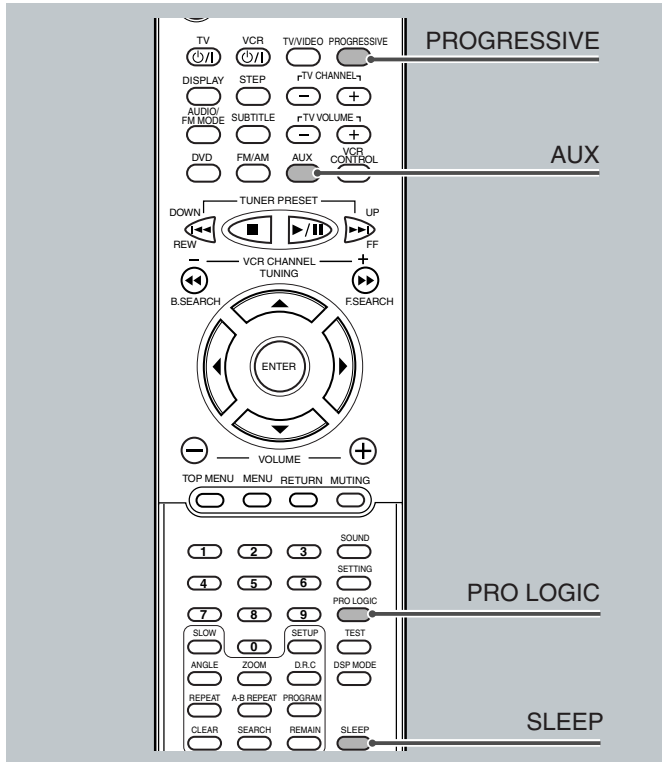

Enjoying Sounds from the External Component

You can enjoy sounds from the external component connected to the AUX IN jacks on the rear panel of the center unit.

1 Select AUX as the source.

From the remote control:

Press **AUX**.

Source changes to the external component connected to the AUX IN jacks.



On the front panel:

Press **SOURCE** repeatedly until "AUX IN" appears on the display.

- Each time you press the button, the source changes as follows:

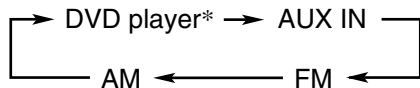

* "WAIT" appears on the display.

2 Start playback on the external component.

- For in-depth information about the external equipment, see the manual supplied for it.

When you listen to analog sounds encoded with Dolby Surround, you can enjoy Dolby Surround.

3 Press PRO LOGIC to activate Dolby Surround.

- Each time you press the button, Dolby Surround mode changes as follows:

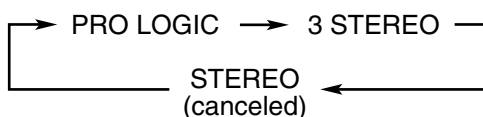

- When Dolby Surround activates, the PRO LOGIC indicator lights up on the display.

For in-depth information about Pro Logic modes, see "Creating Realistic Sound Fields" on pages 20 and 24.

Selecting an Appropriate Progressive Mode

You can select an appropriate progressive mode according to the picture type (film or video source).

From the remote control ONLY:

Press **PROGRESSIVE** repeatedly during playback until the progressive mode you want appears.



- Each time you press the button, the progressive mode changes as follows:

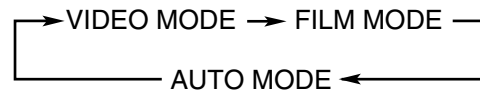

VIDEO MODE : Suitable for playing back a video source disc.
FILM MODE : Suitable for playing back a film or progressive source disc.

AUTO MODE : Normally select this. Used to play a disc containing both video and film source materials.

This system recognizes the picture type (film or video source) of the current chapter.

- If the playback picture is unclear or noisy, or the oblique lines of the picture are rough, try to change to other modes.

Notes:

- This mode is available only when progressive scanning mode is selected (see page 11).
- For VCD/SVCD playback, VIDEO MODE is selected automatically and cannot be changed.

Turning Off the Power with the Timer

You can fall asleep while listening to music—Sleep Timer.

From the remote control ONLY:

Press **SLEEP**.

- Each time you press the button, the shut-off time changes as follows:

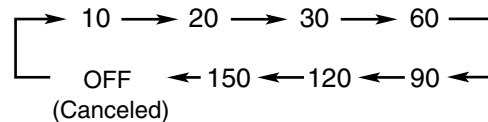

When the shut-off time comes, the system turns off automatically.

To check or change the time remaining until the shut-off time

Press **SLEEP** once.

The remaining time (in minutes) appears on the display.

- By pressing SLEEP, you can change the shut-off time.



To cancel the Sleep Timer

Press **SLEEP** repeatedly until "OFF" appears on the display.

- Turning off the power also cancels the Sleep Timer.



Speaker Settings

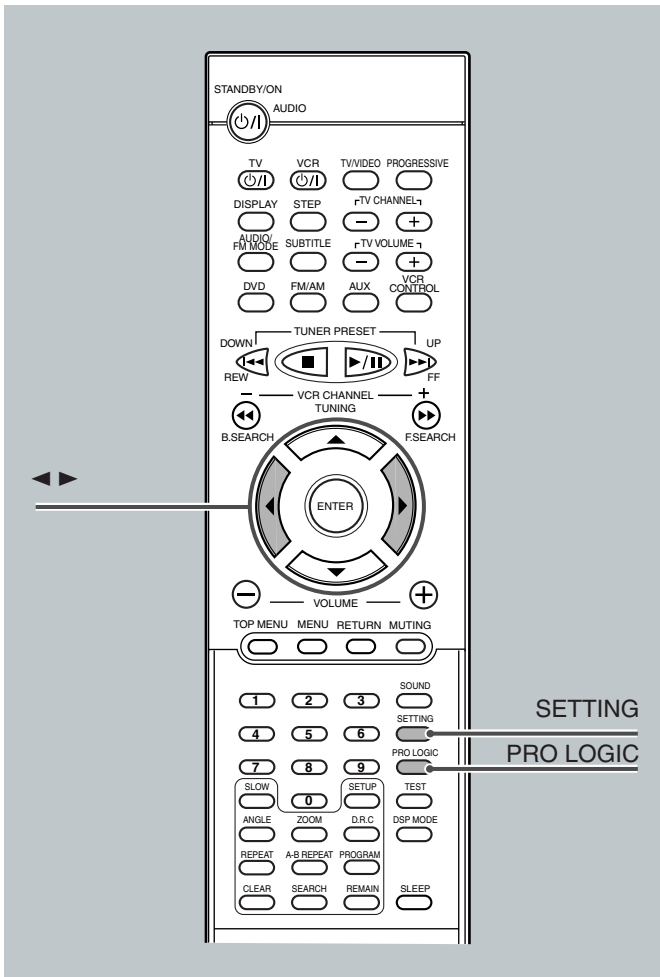

Setting the Delay Time

Adjust the delay time of the sounds from the center speaker and the rear speakers, comparing to that of the sounds from the front speakers. If the distance to the center speaker* and/or the rear speakers** from your listening point is almost the same as from the front speakers, select "00 MS (msec)."

- * You can adjust the delay time only when the DOLBY DIGITAL or DTS indicator is lit on the display.
- ** You can adjust the delay time only when the DOLBY DIGITAL, DTS, or PRO LOGIC indicator is lit on the display.

For Dolby Digital or DTS Digital Surround:

Before you start, remember...

There is a time limit in doing the following steps. If the setting is canceled before you finish, start from step 1 again.

- 1 Select and play a DVD encoded with Dolby Digital or DTS Digital Surround.
- 2 Press **SETTING** repeatedly until one of delay time indications (with the current setting*) appears on the display.

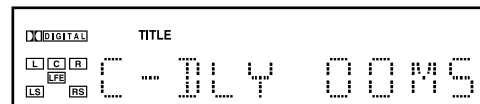

- Each time you press the button, the indication in the main display changes as follows:

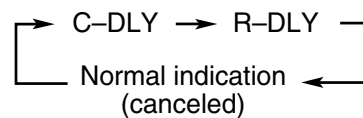

C-DLY (Center delay) : To register delay time for center speaker—from 0 msec to 5 msec

R-DLY (Rear delay) : To register delay time for rear speakers—from 0 msec to 15 msec

- * The initial setting for the center speaker is "00 MS." The initial setting for the rear speakers is "00 MS." If you have already changed the setting, a different value will be shown.

3 Press ► or ◀ to adjust delay time.

- ► : Increases delay time.
- ◀ : Decreases delay time.
- 1 msec increase (or decrease) in delay time corresponds to 30 cm increase (or decrease) in distance.

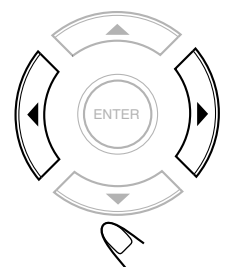

4 Repeat steps 2 and 3 to adjust the other delay time.

Speaker Settings

For Dolby Pro Logic:

Before you start, remember...

There is a time limit in doing the following steps. If the setting is canceled before you finish, start from step 1 again.

- 1 Press **AUX** to select the external component as the source.



- 2 Start playing a source encoded with Dolby Surround.

- 3 Press **PRO LOGIC** repeatedly on the remote control to select Dolby Pro Logic.



- 4 Press **SETTING** repeatedly until one of delay time indications (with the current setting*) appears on the display.

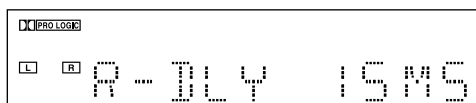

- Each time you press the button, the indication in the main display changes as follows:

R-DLY ↔ Normal indication (canceled)

R-DLY (Rear delay) : To register delay time for rear speakers—from 15 msec to 30 msec.

* The initial setting for the rear speakers is "15 MS."
If you have already changed the setting, a different value will be shown.

- 5 Press **▶** or **◀** to adjust delay time.

- **▶** : Increases delay time.
- **◀** : Decreases delay time.
- 1 msec increase (or decrease) in delay time corresponds to 30 cm increase (or decrease) in distance.

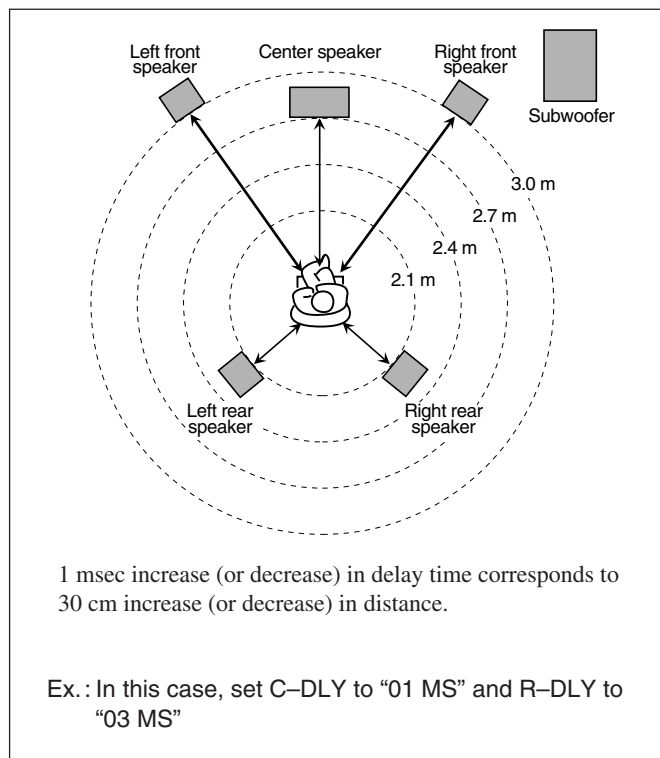
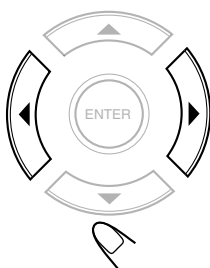

Creating Realistic Sound Fields

You can use the following surround to reproduce a realistic sound field.

- Digital Multichannel Surround—Dolby Digital and DTS Digital Surround
- Dolby Surround
- DSP (Digital Signal Processor) modes

■ Dolby Digital and DTS Digital Surround

To enjoy surround effectively, all the speakers need to be connected and activated.

Dolby Digital*

Used to reproduce multichannel sound tracks of the software encoded with Dolby Digital ().

Dolby Digital encoding method (so-called discrete 5.1 channel digital audio format) records and digitally compresses the left front channel, right front channel, center channel, left rear channel, right rear channel, and LFE channel signals (total 6 channels, but LFE channel is counted as 0.1 channel. Therefore, called 5.1 channel). Since each channel is completely independent from the other channel signals to avoid interference, you can obtain much better sound quality with much stereo and surround effects.

In addition, Dolby Digital enables stereo rear sounds, and sets the cutoff frequency of the rear treble at 20 kHz, compared to 7 kHz for Dolby Pro Logic. These facts enhance the sound movement and being-there feelings much more than Dolby Pro Logic.

When the system detects Dolby Digital signals, the DOLBY DIGITAL indicator lights up on the display.

DTS Digital Surround**

Used to reproduce multichannel sound tracks of the software encoded with DTS Digital Surround ().

DTS Digital Surround is another discrete 5.1 channel digital audio format available on CD, LD, and DVD software.

Compared to Dolby Digital, audio compression rate is relatively low. This fact allows DTS Digital Surround format to add breadth and depth to the reproduced sounds. As a result, DTS Digital Surround features natural, solid and clear sound.

When the system detects DTS Digital Surround signals, the DTS indicator lights up on the display.

■ Dolby Surround*

Used to reproduce sound tracks of the VCR tapes encoded with Dolby Surround ().

This is only used for the sound sources coming through the AUX IN jacks.

Dolby Pro Logic and Dolby 3 Stereo

Dolby Surround encoding format records the left front channel, right front channel, center channel, and rear channel signals (total 4 channels) into 2 channels.

The **Dolby Pro Logic** decoder built in this system decodes these 2 channel signals into original 4 channel signals—matrix-based multichannel reproduction, and allows you to enjoy a realistic stereo sound in your listening room.

When one of Dolby Surround is selected, the PRO LOGIC indicator lights up on the display.

Indications on the display for each surround

• Dolby Digital

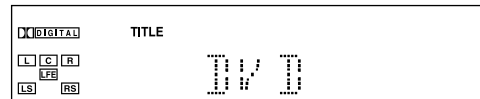

• DTS Digital Surround

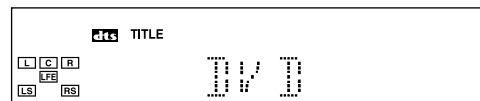

• Dolby Pro Logic

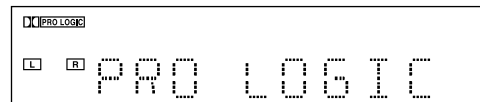

• Dolby 3 Stereo

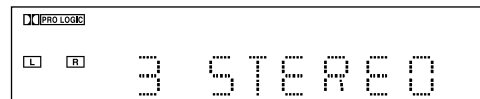

• DSP*

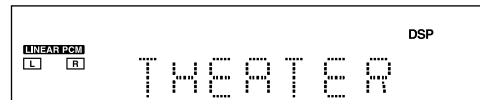

* When you select FM/AM or AUX as the source, the Linear PCM indicator () does not light up.

— According to the speaker settings, some speaker indicators do not light up. In this case, set the speaker setting appropriately (see page 18.)

* Manufactured under license from Dolby Laboratories. "Dolby," "Pro Logic," and the double-D symbol are trademarks of Dolby Laboratories. Confidential Unpublished Works. ©1992–1997 Dolby Laboratories. All rights reserved.

** Manufactured under license from Digital Theater Systems, Inc. US Pat. No. 5,451,942 and other world-wide patents issued and pending. "DTS" and "DTS Digital Surround" are trademarks of Digital Theater Systems, Inc. ©1996 Digital Theater Systems, Inc. All rights reserved.

Creating Realistic Sound Fields

■ DSP (Digital Signal Processor) Modes

DSP modes have been designed to create important acoustic surround elements.

The sound heard in a hall, a theater, a pavilion, a dance club, or a live club consists of direct sound and indirect sound—early reflections and reflections from behind. Direct sounds reach the listener directly without any reflection. On the other hand, indirect sounds are delayed by the distances of the ceiling and walls. These indirect sounds are important elements of the acoustic surround effects.

The following DSP modes are provided with this unit.

THEATER	: Gives the feeling of a theater.
HALL	: Gives clear vocal and the feeling of a concert hall.
LIVE CLUB	: Gives the feeling of a live music club with a low ceiling.
DANCE CLUB	: Gives a throbbing bass beat.

These DSP modes can be used to add the acoustic surround effects while reproducing stereo analog software or Linear PCM digital software, and can give you a real “being there” feeling.

When one of the DSP modes is selected, the DSP indicator lights up on the display.

To check the speaker connections and settings using the test tone

1. Select and play a DVD encoded with Dolby Digital or DTS Digital Surround.
2. Press TEST on the remote control.
The test tone comes out from the speakers (except the subwoofer) in the order.
 - If there is a speaker from which no sounds comes out, check the speaker's connection (see pages 7 and 8).
3. Press TEST again to stop the test tone.



Available surround according to the input signal format

○: Possible ×: Impossible

Surround	Multichannel Surround	Pro Logic*		DSP				(canceled)
		Pro Logic	3 Stereo	THEATER	HALL	LIVE CLUB	DANCE CLUB	STEREO
Input Signal format	Analog	×	○	○	○	○	○	○
	Linear PCM	×	○	○	○	○	○	○
	Dolby Digital Multichannel	○	×	×	×	×	×	×
	Dolby Surround	×	○	○	○	○	○	○
	DTS Digital Surround	○	×	×	×	×	×	×

* You can use Pro Logic mode for all 2 channel sources, but surround effect does not work sufficiently except Dolby Surround encoded source.

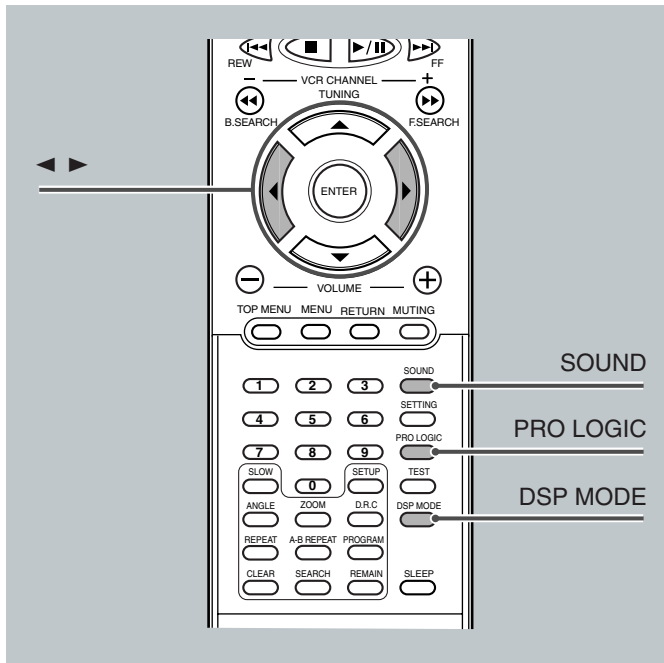

Adjusting Stereo Sound

You can adjust the following settings.

It is recommended that you make adjustments from your actual listening point while listening to reproduced sounds.

- Output balance for the front speakers
- Output level for the subwoofer

Once you adjust these items, the adjustments take effect for all the surround modes.

Before you start, remember...

- There is a time limit in doing the following steps. If the setting is canceled before you finish, start from step **2** again.

1 Select and play any source except Dolby Digital or DTS Digital Surround.

2 Cancel Dolby Surround or DSP modes if they are activated.

For deactivating Dolby Surround:

Press **PRO LOGIC** on the remote control until “STEREO” appears on the display.



For deactivating DSP modes:

Press **DSP MODE** (or **DSP** on the front panel) until the DSP indicator goes off from the display.



Now, you are ready to start adjustments.

- To adjust the output balance for the front speakers, go to the next step.
- To adjust the output level for the subwoofer, go to step **4**.

3 To adjust the output balance for the front speakers

1) Press **SOUND** repeatedly until the adjustment indication for the front speakers appears on the display.



- Each time you press the button, the adjustment indication on the display changes as follows:

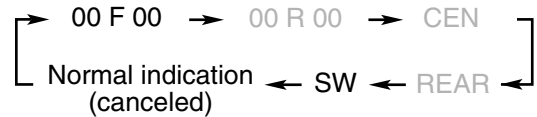

2) Press **▶** or **◀** to adjust the output balance.

- ▶ : Decreases the left speaker output, or restores the right speaker output.

- ◀ : Decreases the right speaker output, or restores the left speaker output.

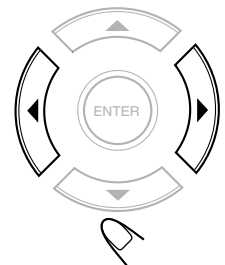

- The output balance changes from OFF (silence), –06 (most reduction) to 00 (no reduction).
- “00 F 00” is the initial setting (the output balance is at the center position). If you have already changed the setting, another value will appear.

4 To adjust the output level for the subwoofer

1) Press **SOUND** repeatedly to select “SW.”



- Each time you press the button, the adjustment indication on the display changes as follows:

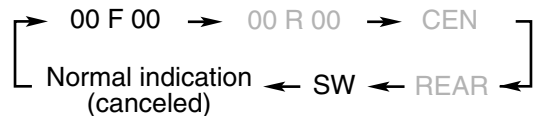

2) Press **▶** or **◀** to adjust the output level.

- ▶ : Increases the output level.
- ◀ : Decreases the output level.

- To adjust the output level for subwoofer (from –6 dB to +6 dB).
- “SW 0dB” is the initial setting. If you have already changed the settings, another value will appear.

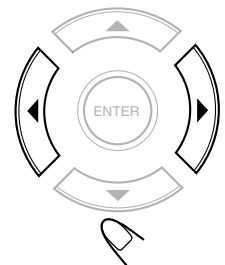

Creating Realistic Sound Fields

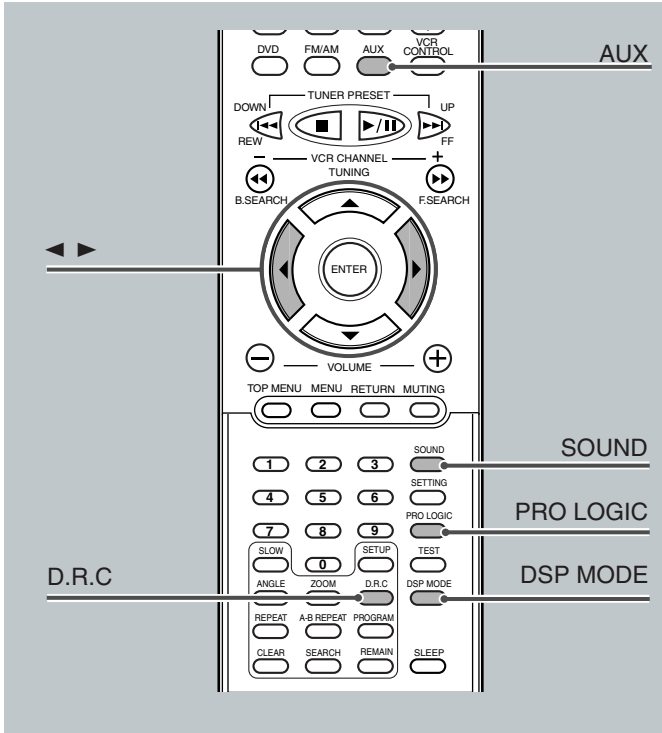

Adjusting Dolby Digital and DTS Digital Surround

You can adjust the following settings while activating Dolby Digital or DTS Digital Surround.

It is recommended that you make adjustments from your actual listening point while listening to reproduced sounds.

- Output balance for the front speakers
- Output balance for the rear speakers
- Output level for the center speaker
- Output level for the rear speakers*
- Output level for the subwoofer

* The adjustment is separately memorized for Digital Multichannel Surround (Dolby Digital and DTS Digital Surround), and for Dolby Pro Logic.

Before you start, remember...

- There is a time limit in doing the following steps. If the setting is canceled before you finish, start from step **2** again.

1 Select and play a DVD encoded with Dolby Digital or DTS Digital Surround.

Now, you are ready to start adjustments.

- To adjust the output balance for the front speakers and the rear speakers, go to the next step.
- To adjust the output level for the center speaker, the rear speakers, and the subwoofer, go to step **3**.

2 To adjust the output balance for the front speakers and the rear speakers

- 1) Press **SOUND** repeatedly until one of the following adjustment indications appears on the display.



- Each time you press the button, the adjustment indication on the display changes as follows:

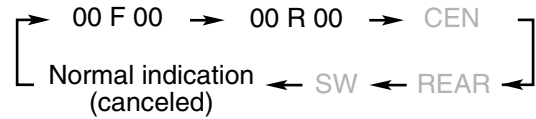

00 F (Front) 00 : To adjust the output balance for the front speakers.

00 R (Rear) 00 : To adjust the output balance for the rear speakers.

- “00 F 00” and “00 R 00” are the initial setting (the output balances are at the center position). If you have already changed the setting, another value will appear.

2) Press ► or ◀ to adjust the output balance.

- : Decreases the left speaker output, or restores the right speaker output.
- ◀ : Decreases the right speaker output, or restores the left speaker output.

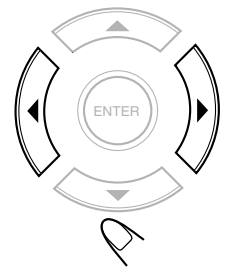

- Each output balance changes from OFF (silence), -06 (most reduction) to 00 (no reduction).

3) Repeat 1) and 2) for setting the other speaker.

3 To adjust the output levels for the center speaker, the rear speakers, and the subwoofer

1) Press **SOUND** repeatedly to select the “CEN,” “REAR,” or “SW.”

- Each time you press the button, the adjustment indication on the display changes as follows:

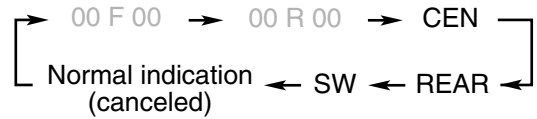

CEN (Center) : To adjust the output level for center speaker (from -6 dB to +6 dB).

REAR : To adjust the output level for rear speakers (from -6 dB to +6 dB).

SW (Subwoofer) : To adjust the output level for subwoofer (from -6 dB to +6 dB).

- “CEN 0dB,” “REAR 0dB,” and “SW 0dB” are the initial settings. If you have already changed the settings, another value will appear.

2) Press ► or ◀ to adjust the output level.

- : Increases the output level.
- ◀ : Decreases the output level.

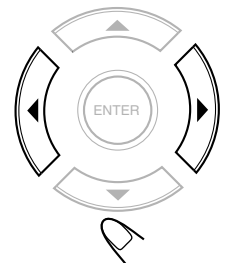

3) Repeat 1) and 2) for setting the other speakers.

Activating Dynamic Range Compression

You can enjoy a powerful sound even at a low volume level by compressing the dynamic range (difference between the maximum and minimum sounds).

- This function takes effect only when Dolby Digital is activated.

From the remote control ONLY:

Press D.R.C.

- Each time you press the button, the dynamic range compression mode alternates between on and off. Select "DRC ON" while watching the DVD at night. (You can obtain a powerful sound at a low volume.)



Adjusting Dolby Surround

You can adjust the following settings while activating Dolby Surround.

It is recommended that you make adjustments from your actual listening point while listening to reproduced sounds.

- Output balance for the front speakers
- Output balance for the rear speakers
- Output level for the rear speakers*
- Output level for the subwoofer
- When Dolby 3 Stereo is activated, you cannot adjust the rear speakers.
- * The adjustment is separately memorized for Digital Multichannel Surround (Dolby Digital and DTS Digital Surround), and for Dolby Pro Logic.
- Dolby Surround cannot be used with DSP modes. Once one of Dolby Surround is activated, DSP modes in use will be canceled.

Before you start, remember...

- There is a time limit in doing the following steps. If the setting is canceled before you finish, start from step **3** again.

1 Press AUX to select the external component as the source.



2 Start playing a source encoded with Dolby Surround.

3 Press PRO LOGIC repeatedly on the remote control to select Dolby Pro Logic or Dolby 3 Stereo.



The PRO LOGIC indicator lights up on the display.

- Each time you press the button, the indication changes as follows:

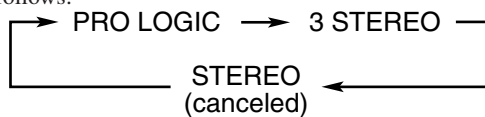

Now, you are ready to start adjustments.

- To adjust the output balance for the front speakers and the rear speakers, go to the next step.
- To adjust the output level for the center speaker, the rear speakers, and the subwoofer, go to step **5** on the next page.

4 To adjust the output balance for the front speakers and the rear speakers

1) Press SOUND repeatedly until one of the following adjustment indications appears on the display.



- Each time you press the button, the adjustment indication on the display changes as follows:

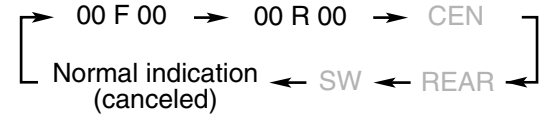

00 F (Front) 00 : To adjust the output balance for the front speakers.

00 R (Rear) 00 : To adjust the output balance for the rear speakers.

- When selecting "3 STEREO," you cannot adjust the output balance for the rear speakers.
- "00 F 00" and "00 R 00" are the initial settings (the output balances are at the center position). If you have already changed the setting, another value will appear.

2) Press ► or ◀ to adjust the output balance.

- : Decreases the left speaker output, or restores the right speaker output.
- ◀ : Decreases the right speaker output, or restores the left speaker output.
- Each output balance changes from OFF (silence), -06 (most reduction) to 00 (no reduction).

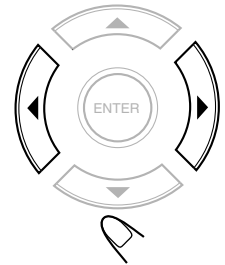

3) Repeat 1) and 2) for setting the other speakers.

Creating Realistic Sound Fields

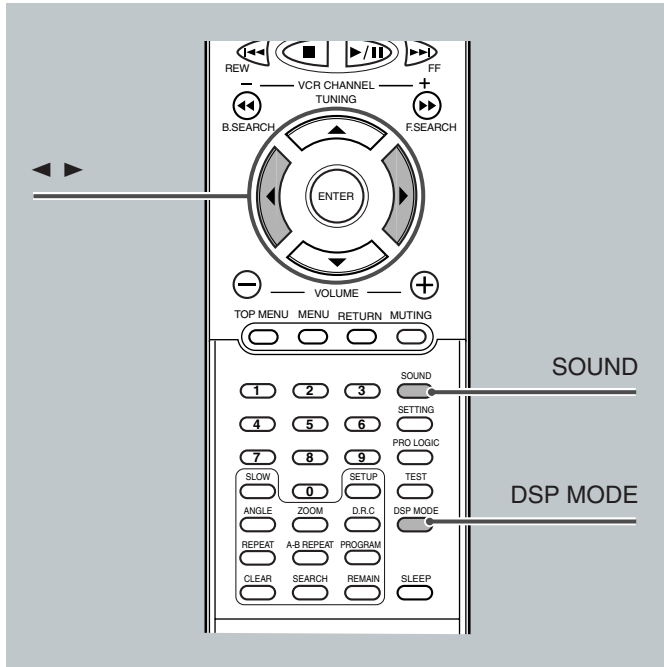

Adjusting DSP Modes

You can adjust the following settings while activating DSP modes. It is recommended that you make adjustments from your actual listening point while listening to reproduced sounds.

- Output balance for the front speakers
 - Output balance for the rear speakers
 - Output level for the rear speakers
 - Output level for the subwoofer
- DSP modes cannot be used with Dolby Surround. Once one of DSP modes is activated, Dolby Surround in use will be canceled.
 - When you play back a DVD encoded with Dolby Digital or DTS Digital Surround, DSP MODE button (or DSP button on the center unit) does not work.

Before you start, remember...

- There is a time limit in doing the following steps. If the setting is canceled before you finish, start from step 2 again.

1 Select and play any source except Dolby Digital or DTS Digital Surround.

2 Press DSP MODE (or DSP on the front panel) repeatedly to select the desired DSP mode.



The DSP indicator lights up on the display while the DSP modes are activated.

- Each time you press the button, DSP mode changes as follows:

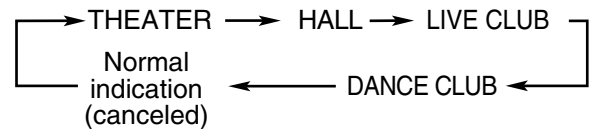

Now, you are ready to start the adjustment.

- To adjust the output balance for the front speakers and the rear speakers, go to the next step.
- To adjust the output level for the rear speakers, go to step 4 on the next page.

5 To adjust the output level for the center speaker, the rear speakers, and the subwoofer

1) Press SOUND repeatedly to select the “CEN,” “REAR,” or “SW.”



- Each time you press the button, the adjustment indication on the display changes as follows:

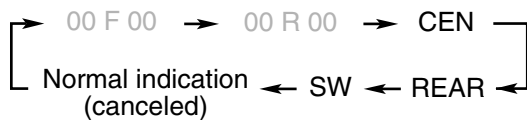

CEN (Center) : To adjust the output level for center speaker (from -6 dB to +6 dB).

REAR : To adjust the output level for rear speakers (from -6 dB to +6 dB).

SW (Subwoofer) : To adjust the output level for subwoofer (from -6 dB to +6 dB).

- When selecting “3 STEREO,” you cannot adjust the output levels for the rear speakers.
- “CEN 0dB,” “REAR 0dB,” and “SW 0dB” are the initial settings. If you have already changed the settings, another value will appear.

2) Press ► or ◀ to adjust the output level.

- : Increases the output level.
- ◀ : Decreases the output level.

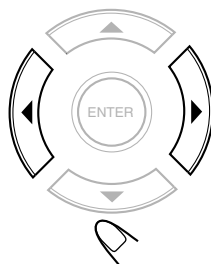

3) Repeat 1) and 2) for setting the other speakers.

3 To adjust the output balance for the front speakers and the rear speakers

1) Press SOUND repeatedly until one of the following adjustment indications appears on the display.



- Each time you press the button, the adjustment indication on the display changes as follows:

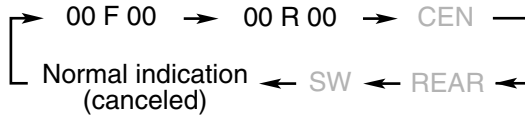

00 F (Front) 00 : To adjust the output balance for the front speakers.

00 R (Rear) 00 : To adjust the output balance for the rear speakers.

- “00 F 00” and “00 R 00” are the initial setting (the output balances are at the center position). If you have already changed the setting, another value will appear.

2) Press ► or ◀ to adjust the output balance.

- : Decreases the left speaker output, or restores the right speaker output.

- ◀ : Decreases the right speaker output, or restores the left speaker output.

- Each output balance changes from OFF (silence), -06 (most reduction) to 00 (no reduction).

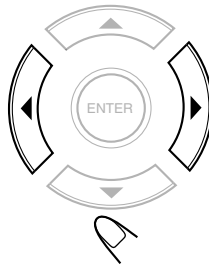

3) Repeat 1) and 2) for setting the other speaker.

4 To adjust the output level for the rear speakers

1) Press SOUND repeatedly until “REAR” appears on the display.



- Each time you press the button, the adjustment indication on the display changes as follows:

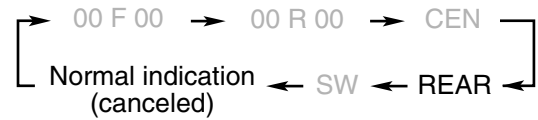

REAR : To adjust the output level for rear speakers (from -6 dB to +6 dB).

- “REAR 0dB” is the initial setting. If you have already changed the setting, another value will appear.

2) Press ► or ◀ to adjust the output level.

- : Increases the output level.

- ◀ : Decreases the output level.

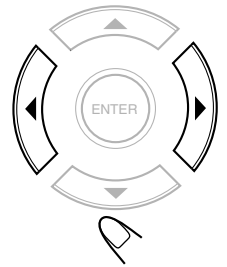

Disc Introduction—DVD/VCD/CD

This system has been designed to play back the following discs: DVD, Video CD, Super Video CD (SVCD), Audio CD, CD-R, and CD-RW.

- This system can also play back MP3 files recorded on CD-Rs and CD-RWs. For in-depth information about what MP3, see “MP3 Introduction” on page 43.

Discs you can play:

Disc Type	Mark (Logo)	Video Format*	Region Code Number**
DVD Video		NTSC	1 ALL
Video CD			_____
Super Video CD			_____
Audio CD			_____
CD-R			_____
CD-RW		_____	

- On some DVD or VCD/SVCD discs, their actual operations may be different from what is explained in this manual. This is due to the disc programming and disc structure, but not a malfunction of this system.
- The following discs cannot be played back:
 - DVD-Audio, DVD-ROM, DVD-RAM, DVD-R, DVD-RW, CD-I, (CD-I Ready), Photo CD, etc.
 Playing back these discs will generate noise and damage the speakers.

* Note on Video Format

This unit accommodates the color system of NTSC. Note that the unit cannot playback the disc recorded with the color system of PAL.

If a DVD recorded with the color system of PAL is loaded, “WRONG DISC” appears on the display and playback cannot start.

** Note on Region Code

DVD players and DVD Video discs have their own Region Code numbers. This system only can play back DVD discs whose Region Code numbers include “1.”

Examples:



If a DVD with the inadequate Region Code numbers is loaded, “REGION ERR” appears on the display and playback cannot start.

IMPORTANT:

Before performing any operations, make sure of the following....

- Check the connection with the TV.
- Turn on the TV and select the correct input on the TV to view the pictures or on-screen indications on the TV screen.
- For DVD playback, you can change the Setup menu setting to your preference. (See pages 49 to 53.)

If “⊗” appears on the TV screen when pressing a button, the disc cannot accept an operation you have tried to do, or information required for that operation is not recorded in the disc.
NOTICE: In some cases, without showing “⊗,” operations will not be accepted.

Disc structure—DVD, Video CD (VCD/SVCD) and Audio CD (CD)

A DVD disc consists of **Titles**, and each title may be divided into some **Chapters**. (See Example 1.)

For example, if a DVD disc contains some movies, each movie may have its own title number, and it may be further divided into some chapters.

On the other hand, a VCD/SVCD or CD consists of **Tracks**. (See Example 2.)

In general, each song has its own track number. (On some discs, each track may also be divided by Indexes.)

When playing back a VCD/SVCD with Playback Control (PBC) function, you can select what to view using the menu shown on the TV screen. (While operating a Video CD using the menu, some of the functions such as Repeat and Track Search may not work.)

Example 1: DVD disc

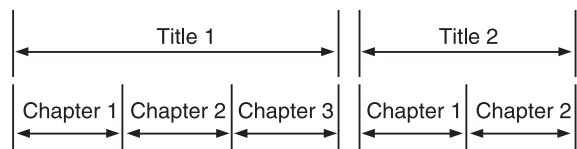

Example 2: Video CD/Audio CD



Notes on CD-R and CD-RW

User-edited CD-Rs (Recordable) and CD-RWs (Rewritable) can be played back only if they are already “finalized.”

- The system can play back CD-Rs or CD-RWs recorded on a personal computer if they have been recorded in the audio CD format or recorded in MP3 format (see page 43). However, they may not be played back depending on their characteristics or recording conditions.
- Before playing back CD-Rs or CD-RWs, read their instructions or cautions carefully.
- Some CD-Rs or CD-RWs may not be played back on this unit because of their disc characteristics, damage or stain on them, or if the built-in lens is dirty.
- CD-RWs may require a longer readout time. This is caused by the fact that the reflectance of CD-RWs is lower than for regular CDs.

Basic Disc Operations

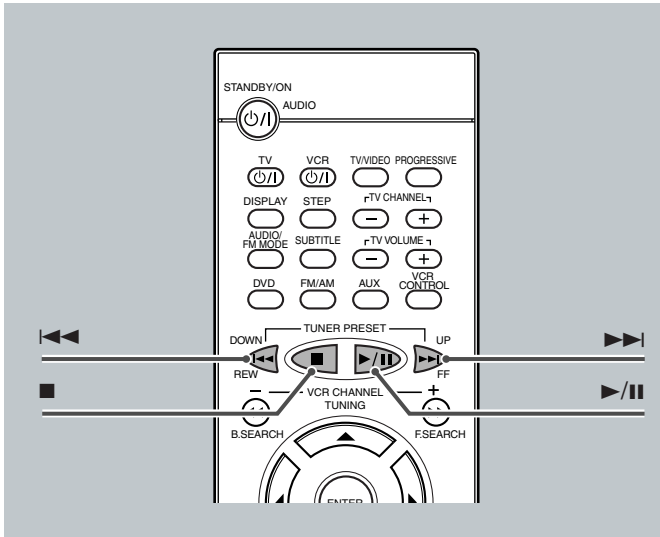

SVCD can be operated by using the VCD operation procedure.

To start playback

Press ►/II.

The source is automatically changed to the DVD player.

“WAIT” appears on the display for a while, then the detected disc type appears—DVD, VCD, CD, or MP3. (If your TV is turned on, the mark corresponding to the detected disc type appears on the TV screen.)

- When a disc is not loaded, “NO DISC” appears on the display.

Disc play starts from the first chapter or track of the selected disc.

- If a menu appears while playing a DVD or VCD with PBC function, see “Disc Menu-Driven Playback” (for DVD) on page 31 or “Disc Menu-Driven Playback (Only for VCD)” on page 38.

Note:

If “WRONG PARENTAL CODE” appears on the TV screen, Parental Lock is in use. You cannot play back a DVD containing violent scenes or those not suitable for your family members.

To play back such a disc, cancel the Parental Lock. (See page 52.)

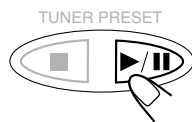

To stop playback for a moment

Press ►/II.

While pausing, minute and second digit of elapsed playing time flashes on the display.

- To resume play, press ►/II again.

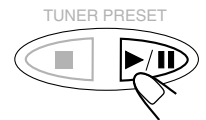

To go to another chapter or track

Press ►► or ◀◀ repeatedly during playback.

- ►► : Skips to the beginning of the next or succeeding chapter or track.
- ◀◀ : While a DVD, a VCD with PBC or MP3 is played back Goes back to the beginning of the previous chapter or track. While a CD or a VCD without PBC is played back Goes back to the beginning of the current or previous track.

To go to another title (only possible on a DVD) or track (only possible on a CD and VCD) directly using the number buttons

Pressing the number buttons before or during play allows you to start playing the title/track number you want. (If your TV is turned on, the on-screen bar is pulled down automatically on the TV screen.)

- To select number 1 to 9, press the corresponding number button (then press ENTER or wait for 5 seconds).
- To select number 15, press 1, 5.
- To select number 23, press 2, 3.

To stop during playback

Press ■.

(If your TV is turned on, “■ STOP” appears on the TV screen.)

- When an MP3 disc is played back, playback stops completely.
- This system can memorize the end point even when you press ■. When you start playback again by pressing ►/II, playback begins from where it has been stopped—Resume play.
- To stop completely, press ■ twice. (“■ STOP” appears on the TV screen.) The disc type appears on the display. The DVD player goes on working for 3 minutes after playback stops.



To remove the disc

Press ▲ on the front panel.

The disc tray comes out.

To close the disc tray, press ▲ again.

- If you do not press the button, the disc tray closes automatically 3 minutes after.

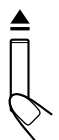

Playback information on the display

DVD

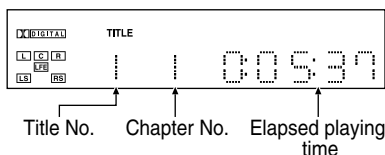

VCD/CD

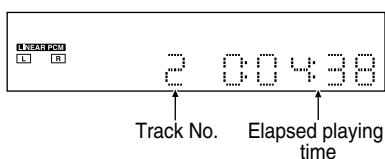

MP3

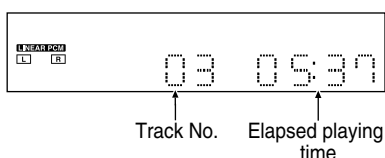

DVD Playback

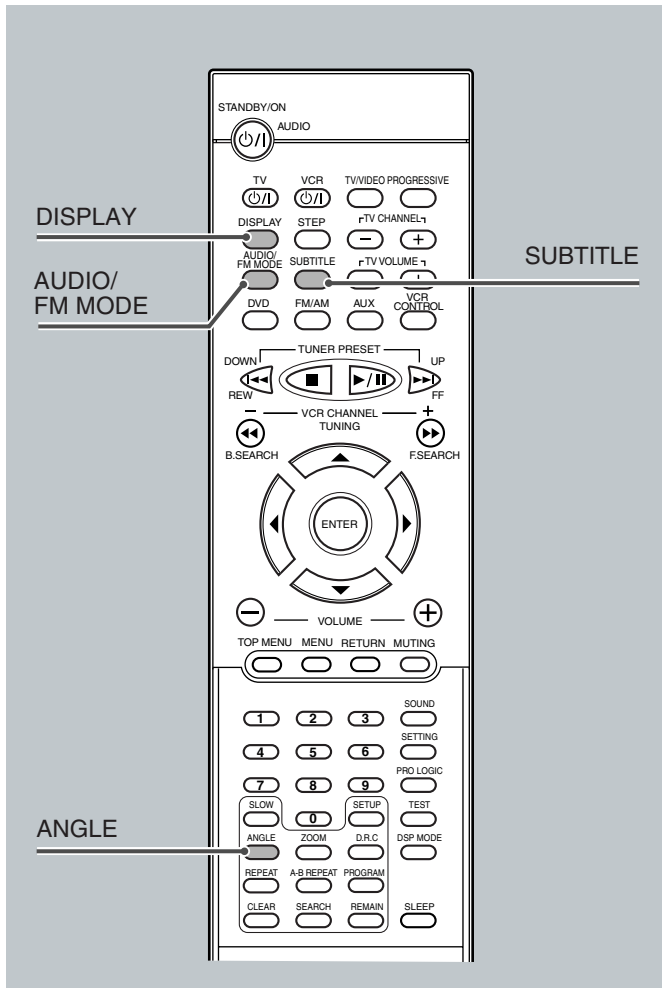

Some DVDs contain several audio languages, subtitles, and multi-angle views. When you find the following marks on the DVD or its package, you can select these elements recorded on the DVD.

	Subtitles are recorded on the disc. The number inside the mark indicates the total number of the recorded subtitles.
	Several audio languages are recorded on the disc. The number inside the mark indicates the total number of the recorded audio languages.
	Multi-angle views are recorded on the disc. The number inside the mark indicates the total number of the recorded multi-angle views.

If you cannot find out whether your disc contains these features listed above, you can check it by showing the on-screen bar.

For basic disc operations such as inserting a disc, starting playback, and moving to another chapters, see “Basic DVD Operations” on pages 12, 13, and “Basic Disc Operations” on page 28.

Showing the On-Screen Bar

You can show the following information on the TV screen while a disc is loaded.

From the remote control ONLY:

Press **DISPLAY**.

- Each time you press the button, the following on-screen bar appears in sequence.



① : Disc type DVD VCD SVCD CD MP3
② : Current title and total number of the titles on the disc • Ex.: 1st title is playing out of 3 titles recorded.
③ : Current chapter and total number of the chapters in the current title • Ex.: 1st chapter is playing out of 5 chapters recorded.
④ : Elapsed playing time or remaining time You can change the play time indication by pressing REMAIN . See page 31 for more details.
⑤ : Subtitle language indication • Ex.: When no subtitle is recorded on the disc. See page 30 for more details.
⑥ : Audio language indication • Ex.: Original sound (default) is selected out of 3 audio languages recorded. See page 30 for more details.
⑦ : Signal format indicator • Signal format type—Linear PCM (stereo), Dolby Digital, and DTS Digital Surround—will be indicated. Ex.: When the disc is encoded with Dolby Digital.
⑧ : Repeat mode indicator • Ex.: When repeat mode is turned off. See page 33 for more details.
⑨ : Multi-angle view indicator • Ex.: When only a single angle-view is recorded on the disc. See page 30 for more details.

Selecting the Subtitles

While playing back a DVD containing subtitles in different languages, you can select the subtitle to be displayed on the TV screen.

- You can set your favorite subtitle language as the initial language shown on the screen. (See page 49.)

From the remote control ONLY:

Press SUBTITLE.

The on-screen bar appears on the TV screen for a while.

- Each time you press the button, the subtitle language changes as follows:

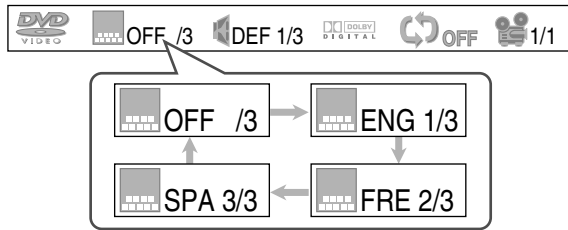

Ex.: When the disc has 3 selections—English, French, Spanish and no subtitle (OFF)



Selecting the Multi-Angle Views

While playing back a DVD containing multi-angle views, you can view the same scene at different angles.

- When you play back the DVD containing multi-angle views,  appears on the TV screen.

From the remote control ONLY:

Press ANGLE.

- Each time you press the button, the view angle changes.

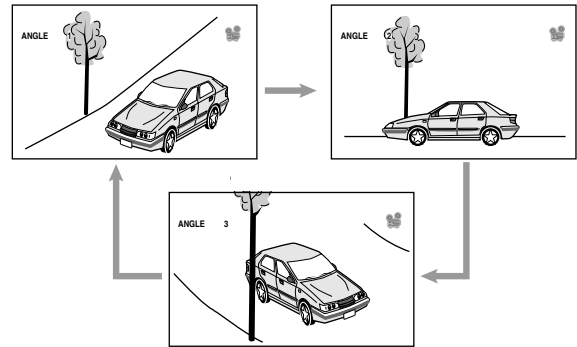

Ex.: When the disc has 3 multi-angle views



Note:

When the on-screen bar is shown on the TV screen, Multi angle view indication also changes as follows:

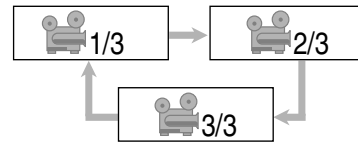

Selecting the Audio Languages

While playing back a DVD containing audio languages (sound track), you can select the language (sound track) to listen to.

- You can set your favorite audio language as the initial audio language. (See page 49.)

Press AUDIO/FM MODE.

The on-screen bar appears on the TV screen for a while.

- Each time you press the button, the audio language changes as follows:

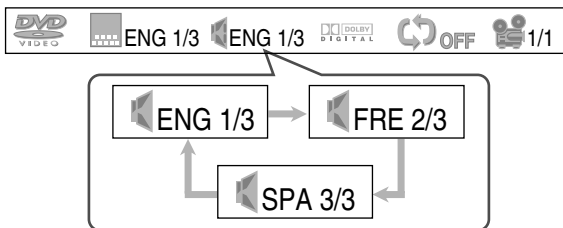

Ex.: When the disc has 3 selections—English, French, and Spanish



DVD Playback

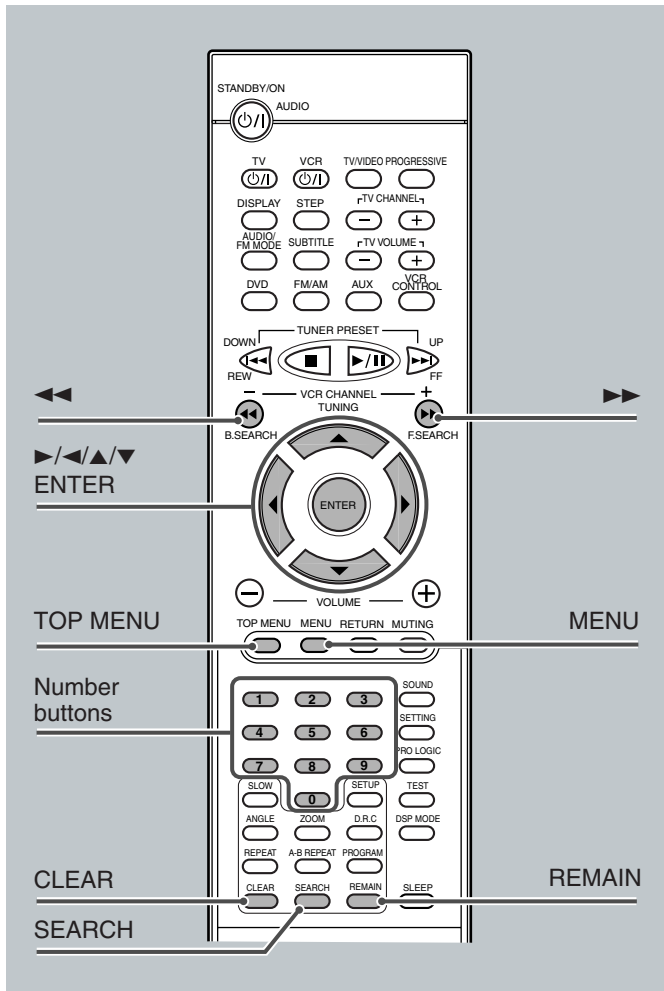

Disc Menu-Driven Playback

Disc menu-driven playback is possible while playing back a DVD with menu (menu may be still pictures or moving pictures depending on the disc).

- When operating a disc using the disc menu, refer also to the instructions supplied for the disc.

DVD discs generally have their own menus or title lists. A menu usually contains various information about the disc and playback selections. On the other hand, a title list usually contains titles of movies and songs recorded.

From the remote control ONLY:

1 Press MENU or TOP MENU.

A menu or title list will appear on the screen.

“MENU” appears on the display.

- On some DVDs, a menu will automatically appear on the screen after playback starts.



2 Select a desired item on the menu or on the title list, using \blacktriangleleft/\blacktriangleright/\blacktriangleup/\blacktriangledown and ENTER.

The unit starts playback of the selected item.

- On some discs, you can also select items by pressing the number buttons corresponding to the item numbers listed.

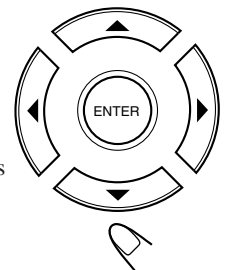

Checking the Remaining Time

While playing back a DVD, you can check the remaining time to be played back.

From the remote control ONLY:

Press **REMAIN**.

The on-screen bar and the current play time indication appear on the TV screen for a while.

- Each time you press the button, the following indication appears on the screen:

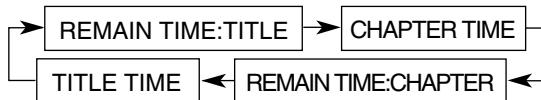

REMAIN TIME:TITLE

: Select this to show the remaining time of the current title.

CHAPTER TIME

: Select this to show the elapsed playing time of the current chapter.

REMAIN TIME:CHAPTER

: Select this to show the remaining time of the current chapter.

TITLE TIME

: Select this to show the elapsed playing time of the current title.

Moving to a Particular Portion Directly

You can move to another title, chapter, or particular scene in the chapter directly.

From the remote control ONLY:

- 1** Press **SEARCH** during playback or pause. 
- Each time you press the button, the following indication appears on the screen:

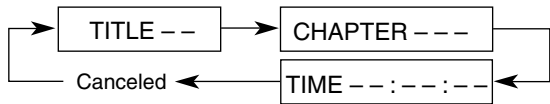

- TITLE --** : Select this to move to another title.
CHAPTER --- : Select this to move to another chapter.
TIME ---:---:--- : Select this to move to a particular scene.

- 2** Press the number buttons to select a desired title, chapter, or playing time.

The unit starts playback of the selected item. (The on-screen bar appears for a while.)

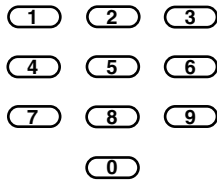

How to input the title and chapter number

Press the number buttons corresponding to the number, then wait for about 5 seconds or press ENTER to start playback.

- To select number 5, press 5, then ENTER.
- To select number 12, press 1, 2, then ENTER.
- To select number 22, press 2, 2, then ENTER.

How to input the playing time

Press the number buttons to input the playing time, then wait for about 5 seconds or press ENTER to start playback at the selected elapsed playing time.

- To input time "00:45:23," press 4, 5, 2, 3.
- To input time "01:23:45," press 1, 2, 3, 4, 5.
- To cancel a mis-entry, press CLEAR.

Each time you press the button, the last entry will be erased.

Note:

When you want to move to another title directly, you can move to it by simply pressing the corresponding number buttons (without pressing **SEARCH** in step 1).

Searching for a Particular Point

You can search for a particular point while playing a disc—Variable Speed Forward/Reverse Search.

- No sound comes out during Variable Speed Forward/Reverse Search.

To fast-forward the chapter—Variable Speed Forward Search

From the remote control ONLY:

Press **F.F.** during playback or pause.

- Each time you press the button, the search speed changes as follows:

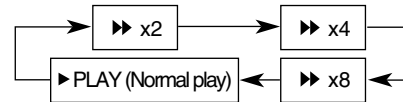

To reverse the chapter—Variable Speed Reverse Search

From the remote control ONLY:

Press **B.B.** during playback or pause.

- Each time you press the button, the search speed changes as follows:

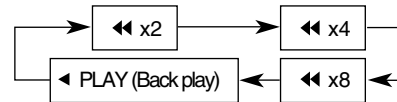

To resume normal play

Press **PLAY/PAUSE**.

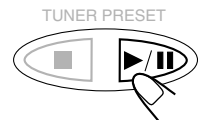

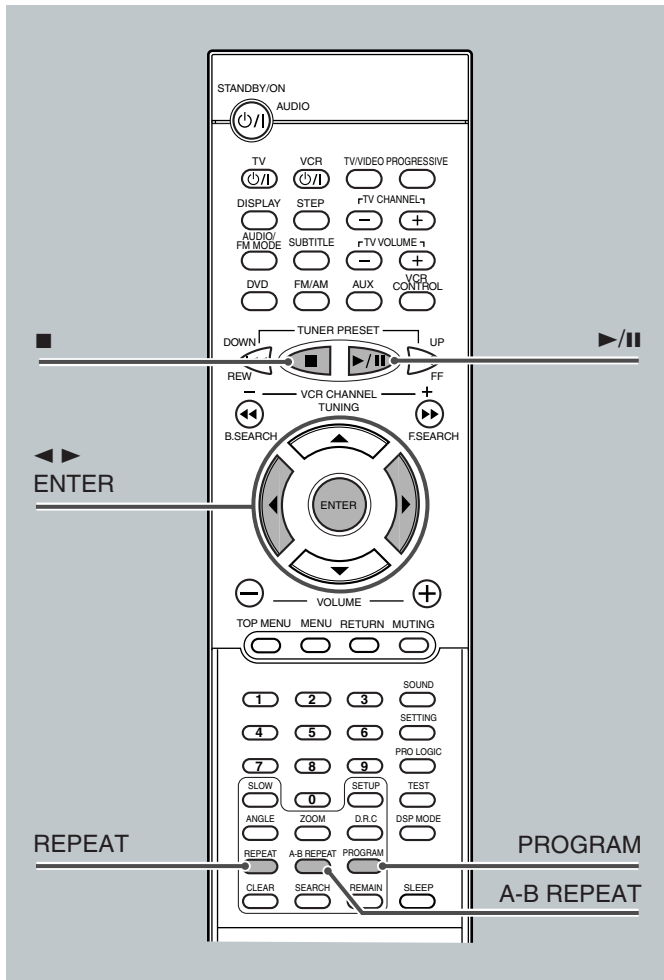

Repeating Playback

Repeat play cannot be used in the following cases:

- When you enjoy program play

Repeat Play

From the remote control ONLY:

Press **REPEAT** repeatedly.

The indication corresponding to the selected mode appears on your TV.

- Each time you press the button, Repeat mode changes as follows:

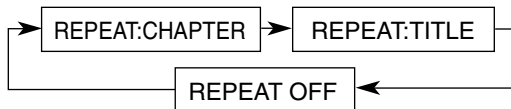

- REPEAT:CHAPTER** : Current chapter will be repeated.
- REPEAT:TITLE** : Current title will be repeated.
- REPEAT OFF** : Repeat play is canceled. (Normal play is resumed.)

Note:

When the on-screen bar is shown on the TV screen, Repeat mode indication also changes as follows:

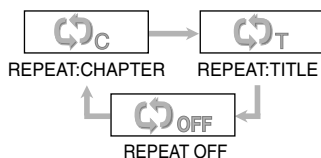

A-B Repeat

While playing, you can also select a portion you want to repeat.

- A-B repeat is not performed between different titles.
- An interval of more than 5 seconds is required between point A and point B.

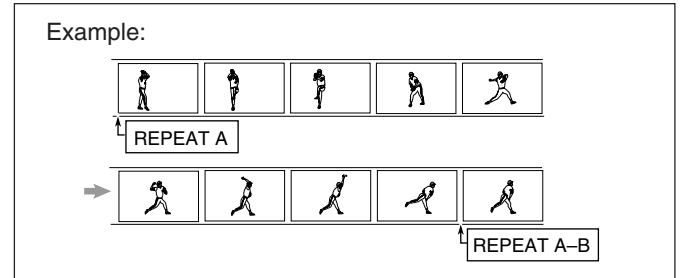

From the remote control ONLY:

1 Press **A-B REPEAT** to select the start point.

“REPEAT A” appears on the display.



2 Press **A-B REPEAT** again to select the end point.

“REPEAT A” changes to “REPEAT A-B,” then A-B repeat begins.

The unit automatically locates point A and starts repeated playback between points A and B.



To cancel A-B Repeat

Press **A-B REPEAT** again.

“REPEAT A-B” goes off from the display.



Note:

When the on-screen bar is shown on the TV screen, Repeat mode indication also changes as follows:

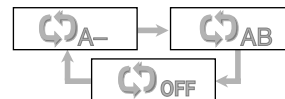

On some DVDs, A-B Repeat may not be used even within the same title. This is due to their disc structures, and not a malfunction of the unit.

Programming the Playing Order of the Chapters—Program Play

You can arrange the chapter playback order before you start playing. You can program up to 20 steps.

- Before making a program, make sure that the TV is turned on and the correct input is selected on the TV.

From the remote control ONLY:

1 Load a disc.

- If the current playing source is not the DVD player, press ►/II, then ■ before going to the next step.

2 Press PROGRAM.

The PROGRAM MENU screen appears on the TV screen.

- “PROGRAM” appears on the display.



PROGRAM MENU		SELECT: ENTER	
TITLE	CHAPT	TITLE	CHAPT
1	-- --	6	-- --
2	-- --	7	-- --
3	-- --	8	-- --
4	-- --	9	-- --
5	-- --	10	-- --

PREVIOUS ↑ NEXT ↓

PLAY: ► FINISH: PROGRAM

3 Press ENTER.

PROGRAM MENU		SELECT: ENTER	
TITLE	CHAPT	TITLE	CHAPT
1	-- --	6	-- --
2	-- --	7	-- --
3	-- --	8	-- --
4	-- --	9	-- --
5	-- --	10	-- --

CHOOSE: 1-5

PREVIOUS ↑ NEXT ↓

PLAY: ► FINISH: PROGRAM

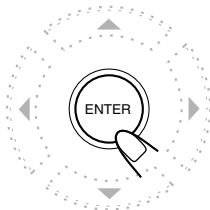

Title numbers you can select in the next step

4 Press ► or ◀ to select a title number, then ENTER.

- ► : Increases the number.
- ◀ : Decreases the number.
- You can also select a title number using the number buttons.

PROGRAM MENU		SELECT: ENTER	
TITLE	CHAPT	TITLE	CHAPT
1	-2 --	6	-- --
2	-- --	7	-- --
3	-- --	8	-- --
4	-- --	9	-- --
5	-- --	10	-- --

CHOOSE: 1-9

PREVIOUS ↑ NEXT ↓

PLAY: ► FINISH: PROGRAM

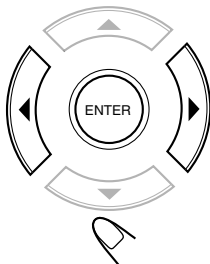

Chapter numbers you can select in the next step

5 Press ► or ◀ to select a chapter number, then ENTER.

- ► : Increases the number.
- ◀ : Decreases the number.
- You can also select a chapter number using the number buttons.

PROGRAM MENU		SELECT: ENTER	
TITLE	CHAPT	TITLE	CHAPT
1	2 8	6	-- --
2	-- --	7	-- --
3	-- --	8	-- --
4	-- --	9	-- --
5	-- --	10	-- --

PREVIOUS ↑ NEXT ↓

PLAY: ► FINISH: PROGRAM

- To select all chapters in the selected title as one program step, simply press ENTER without selecting any number. “ALL” appears on the chapter number position.

6 Repeat steps 3 to 5 to program other chapters you want.

- After 10 steps are programmed, “NEXT ↓” is selected (highlighted). If you want to program more steps, press ENTER.

7 Press ►/II.

The chapters are played in the order you have programmed and the PROGRAM indicator lights up.

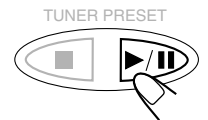

After all the chapters you programmed are played back, the PROGRAM MENU screen appears on the TV screen again.

To stop during playback

Press ■ or PROGRAM on the remote control.

The PROGRAM MENU screen appears on the TV screen.

- If you press ►/II while this screen is shown, the unit starts program play.



PROGRAM MENU		SELECT: ENTER	
TITLE	CHAPT	TITLE	CHAPT
1	2 8	6	2 2
2	1 5	7	2 12
3	1 17	8	1 9
4	3 6	9	-- --
5	4 2	10	-- --

PREVIOUS ↑ NEXT ↓

PLAY: ► FINISH: PROGRAM

TO BE CONTINUED ON THE NEXT PAGE

DVD Playback

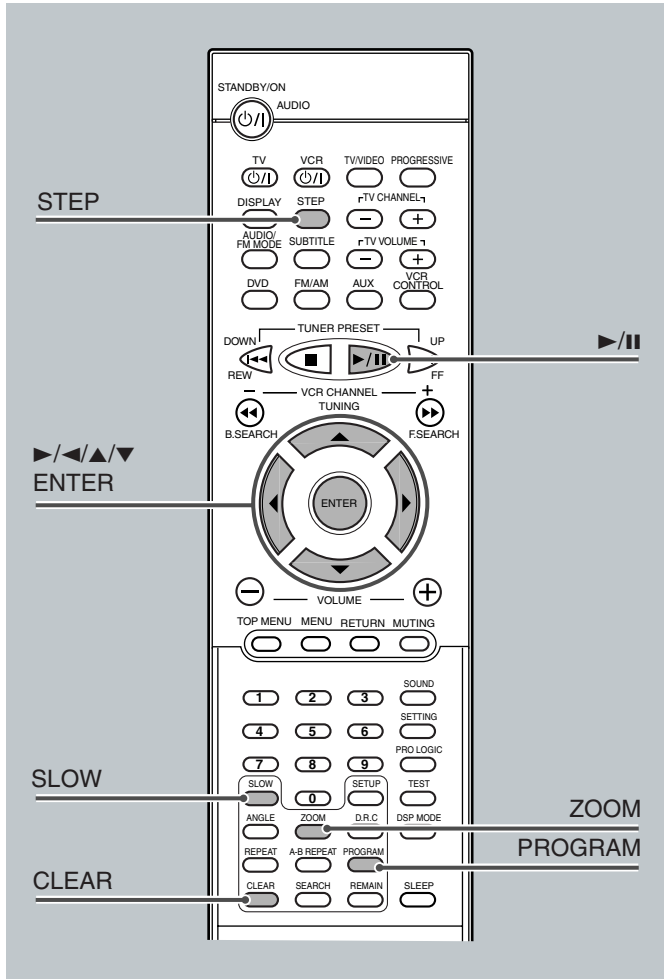

To erase the stored program

Press **▲** to eject the disc.

- If you turn off the system or change the source, the program is also erased.



To check the program contents

You can check the program contents by pressing PROGRAM. The PROGRAM MENU screen appears on the TV screen.

- If you press the button during playback, the program play will stop.

To modify the program

You can modify the program while the PROGRAM MENU screen is shown on the TV screen.

- **To erase a step:** Press **▼** (or **▲**) to select (highlight) an unwanted program step, then press CLEAR.
- **To modify a step:** Press **▼** (or **▲**) to select (highlight) a program step you want to modify, then perform steps **3** to **5** on page 34. (Before entering a new number, press CLEAR repeatedly until “-” appears on the number entry position.)
- **To add a step:** Press **▼** (or **▲**) to select (highlight) an empty program step, then perform steps **3** to **5** on page 34.

- To move to program step 10 from program step 11, press **▲** when program step 11 is selected (highlighted) so that “PREVIOUS **↑**” is selected (highlighted). Then, press ENTER.
- To move to program step 11 from program step 10, press **▼** when program step 10 is selected (highlighted) so that “NEXT **↓**” is selected (highlighted). Then, press ENTER.

To exit from program play

From the remote control ONLY:

Press PROGRAM.

The PROGRAM MENU screen goes off, and the opening screen appears. (The program you made is still kept in memory.)



- If you press **▶/||** while this screen is shown, the unit starts normal playback.



DVD Special Effect Playback

■ Still Picture/Frame-by-Frame Playback

You can advance the still picture frame by frame while playing a DVD.

From the remote control ONLY:

1 Press STEP once during playback.

A still picture appears on the TV screen.



2 Press STEP repeatedly to advance the picture frame by frame.

- Each time you press the button, the picture advances frame by frame.



To resume normal play

Press ►/II.

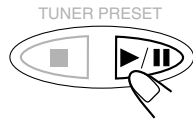

■ Slow Motion Playback

You can enjoy slow motion playback while playing a DVD.

From the remote control ONLY:

Press SLOW repeatedly during playback or pause.

- Each time you press the button, slow motion speed changes as follows:

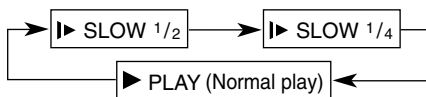

■ Zoom

You can zoom in on the picture while playing back a DVD.

From the remote control ONLY:

1 Press ZOOM to zoom in.

- Each time you press the button, the picture is enlarged as follows:

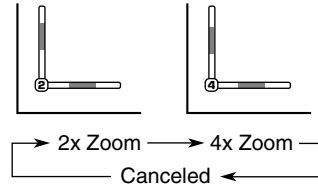

2 Press ►/◀/▲/▼ to move the enlarged portion you want to watch.

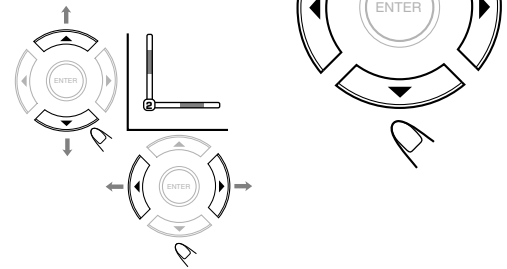

To cancel the ZOOM

Press ZOOM repeatedly until the normal size picture is resumed.



VCD/CD Playback

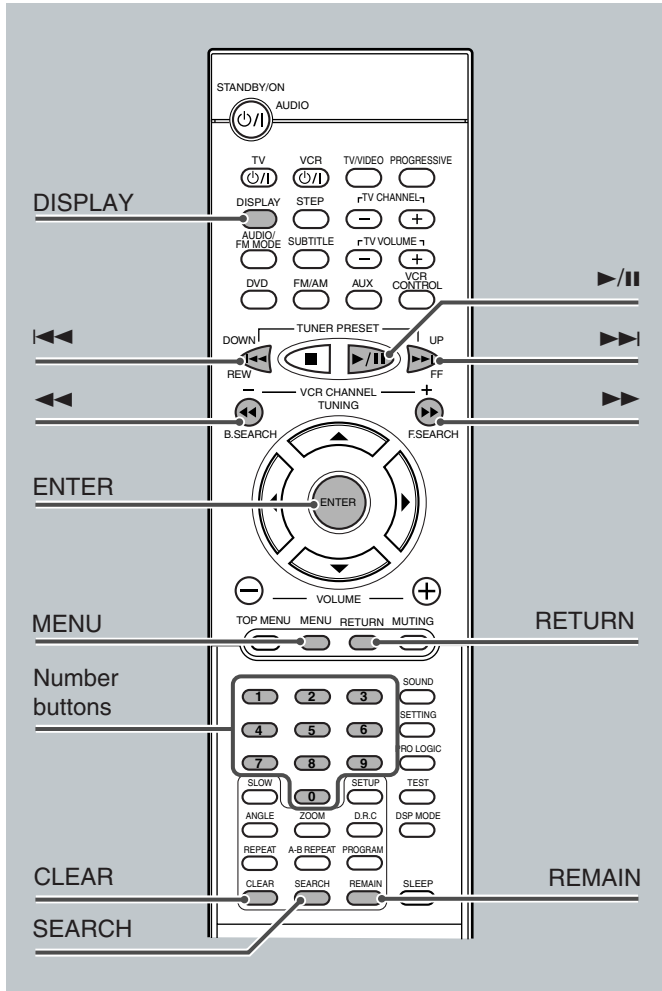

- SVCD can be operated by using the VCD operation procedure.
- For basic disc operations such as inserting a disc, starting playback, and moving to another tracks, see "Basic VCD/CD Operations" on pages 14, 15, and "Basic Disc Operations" on page 28.

Showing the On-Screen Bar

You can show the following information on the TV screen while a disc is loaded.

From the remote control ONLY:

Press **DISPLAY**.

- Each time you press the button, the following on-screen bar appears in sequence.



The on-screen bar displays the following information:

- 1: Disc type**
DVD, VCD, SVCD, CD, MP3
- 2: Current track and total number of the tracks on the disc**
• Ex.: 1st track is playing out of 35 tracks recorded.
- 3: Sound mode**
• Ex.: Stereo sound (Left channel and Right channel).
- 4: Play Back Control (PBC) indicator**
• Ex.: PBC is on. (When PBC is turned off, will appear.)
- 5: Repeat mode indicator**
• Ex.: When repeat mode is turned off. See page 39 for more details.
- 6: Elapsed playing time or remaining time**
You can change the play time indication by pressing **REMAIN**. See below.
- 7: Sound indication**
• Indicates sound input level. (Appears only during playback VCD.)

Checking the Remaining Time

While playing back a VCD or CD, you can check the remaining time.

From the remote control ONLY:

Press **REMAIN**.

The on-screen bar appears on the TV screen for a while.

- Each time you press the button, the play time indication changes as follows:

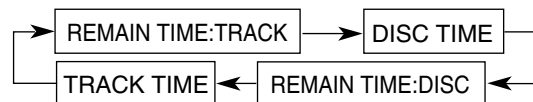

REMAIN TIME:TRACK

: Select this to show the remaining time of the current track.

DISC TIME

: Select this to show the total elapsed playing time of the disc.

REMAIN TIME:DISC

: Select this to show the total remaining time of the disc.

TRACK TIME

: Select this to show the elapsed playing time of the current track.

Disc Menu-Driven Playback (Only for VCD)

The Play Back Control function (PBC) allows you to operate the VCD using menus.

When you start playing a VCD with PBC function, a menu will automatically appear on the TV screen. ("MENU" will also appear on the display.)

- A menu may be a list of items, divided screens, or some moving pictures. (See "PBC operation concept" below.)

When a menu appears, you can select a desired item on the menu.

- When a list of items is displayed on the TV screen, press the number buttons to select an item.
- When "▶" or "SELECT" is displayed on the TV screen, press ▶/II to start playback.

To go to the next submenu

Press ▶▶.



To return to the previous submenu

Press ◀◀.



To cancel the PBC playback

You can cancel the menu-driven operations (PBC function):

- 1 Press ■ to stop playback.
- 2 Press the number buttons to select a track.

Normal playback starts from the selected track.

- You can also turn on and off the PBC function by pressing MENU on the remote control. Each time you press the button, the PBC function turns on and off.

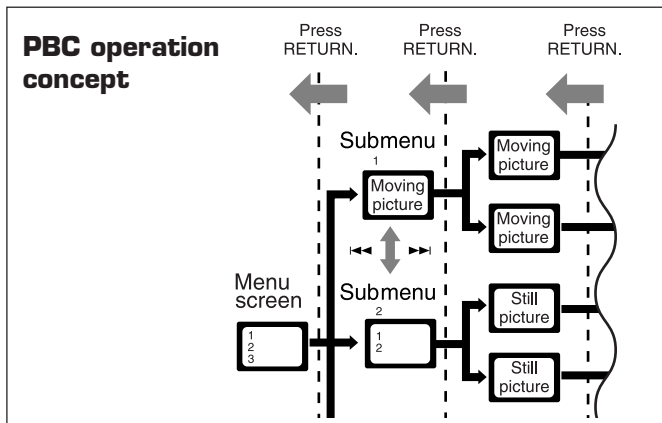

Note:

While operating a VCD using menu, some of the functions such as repeat play may not work.

Moving to a Particular Portion Directly

You can move to a particular portion (scene) on the track directly.

- PBC function is canceled when you use this function.

From the remote control ONLY:

1 Press SEARCH during playback or pause.

- Each time you press the button, the following indication appears on the TV screen.

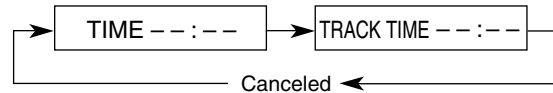

TIME -- : -- : Select this to move to a particular portion on the current disc.

TRACK TIME -- : -- : Select this to move to a particular portion on the current track.

2 Press number buttons to select a playing time you want to search for.

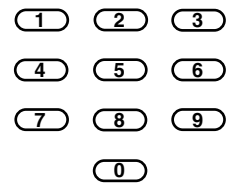

The unit starts playback at the selected elapsed playing time. (The on-screen bar appears for a while.)



- To input time "45:23," press 4, 5, 2, 3.
- To input time "09:45," press 9, 4, 5, then wait for about 5 seconds (or press ENTER).
- To cancel a misentry, press CLEAR. Each time you press the button, the last entry will be erased.

Searching for a Particular Point

You can search for a particular point while playing a disc—Variable Speed Forward/Reverse Search.

- No sound comes out during Variable Speed Forward/Reverse Search on a VCD.

To fast-forward the tracks—Variable Speed Forward Search

Press ▶▶ during playback or pause.

- Each time you press the button, the search speed changes as follows:

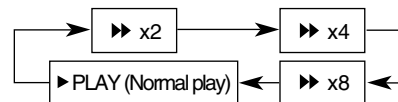

To reverse the tracks—Variable Speed Reverse Search

Press ◀◀ during playback or pause.

- Each time you press the button, the search speed changes as follows:

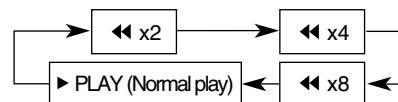

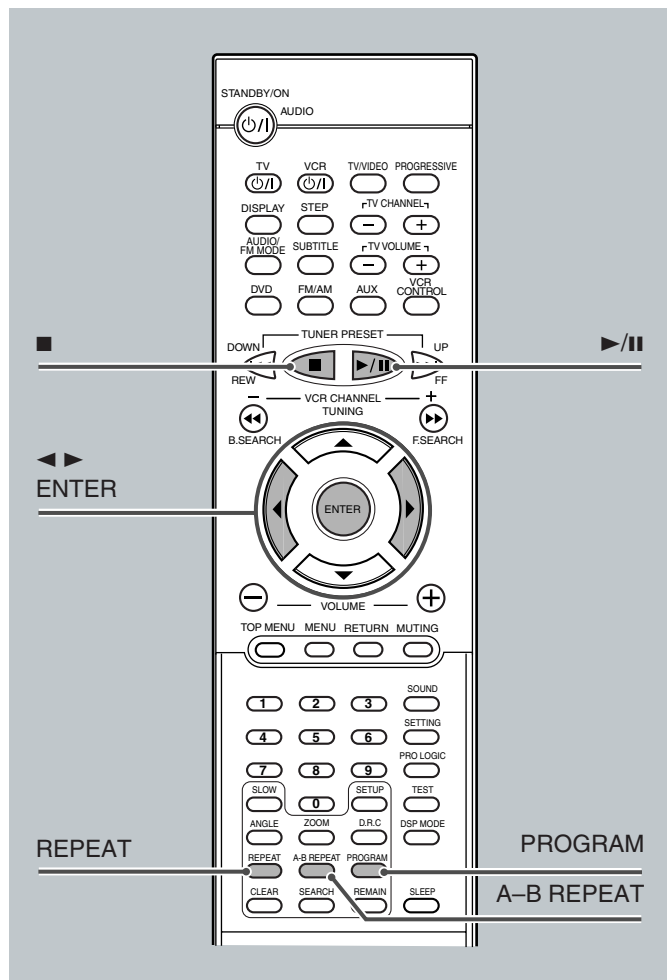

Repeating Playback

Repeat play cannot be used in the following cases:

- When you play back a VCD using the PBC function
- When you enjoy program play

Repeat Play

From the remote control ONLY:

Press **REPEAT** repeatedly.

The indication corresponding to the selected mode appears on your TV.

- Each time you press the button, repeat mode changes as follows:

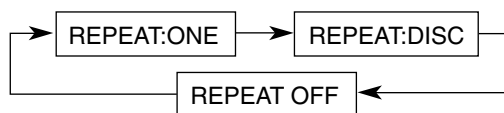

- REPEAT:ONE** : Current track will be repeated.
- REPEAT:DISC** : All the tracks will be repeated.
- REPEAT OFF** : Repeat play is canceled. (Normal play is resumed.)

Note:

When the on-screen bar is shown on the screen, Repeat mode indication also changes as follows:

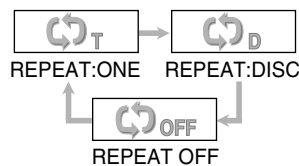

A-B Repeat

While playing, you can also select a portion you want to repeat.

- An interval of more than 5 seconds is required between point A and point B.

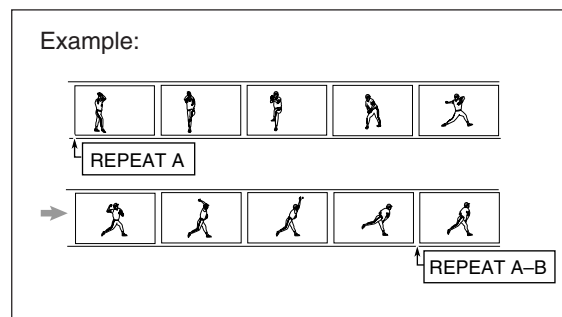

From the remote control ONLY:

1 Press **A-B REPEAT** to select the start point.

“REPEAT A” appears on the display.



2 Press **A-B REPEAT** again to select the end point.

“REPEAT A” changes to “REPEAT A-B,” then A-B Repeat begins.

The unit automatically locates point A and starts repeated playback between points A and B.



To cancel A-B Repeat

Press **A-B REPEAT** again.

“REPEAT A-B” goes off from the display.



Note:

When the on-screen bar is shown on the TV screen, Repeat mode indication also changes as follows:

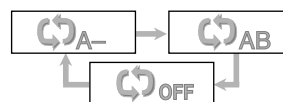

Programming the Playing Order of the Tracks—Program Play

You can arrange the track playback order before you start playing. You can program up to 20 steps.

- Before making a program, make sure that the TV is turned on and the correct input is selected on the TV.

From the remote control ONLY:

1 Load a disc.

- If the current playing source is not the DVD player, press ►/||, then ■ before going to the next step.

2 Press PROGRAM.

The PROGRAM MENU screen appears on the TV screen.

- “PROGRAM” appears on the display.

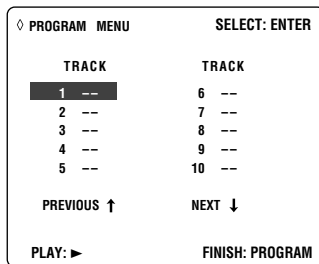

3 Press ENTER.

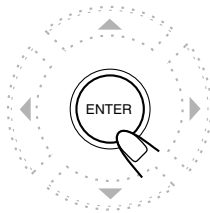
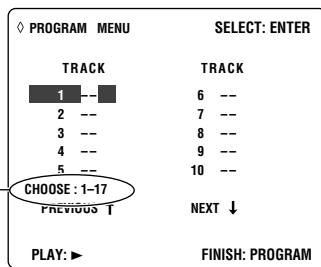

Track numbers you can select in the next step

4 Press ► or ◀ to select a track number, then ENTER.

- ► : Increases the number.
- ◀ : Decreases the number.
- You can also select a track number using the number buttons.

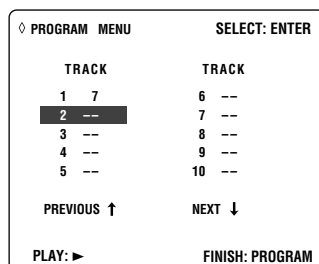
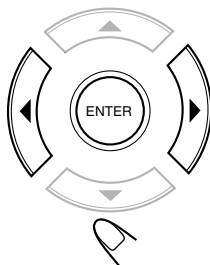

5 Repeat steps 3 and 4 to program other tracks you want.

- After 10 steps are programmed, “NEXT ↓” is selected (highlighted). If you want to program more steps, press ENTER.

6 Press ►/||.

The tracks are played in the order you have programmed and the PROGRAM indicator lights up.



After all the tracks you programmed are played back, the PROGRAM MENU screen appears on the TV screen again.

To stop during play

Press ■ or PROGRAM on the remote control.

The PROGRAM MENU screen appears on the TV screen.

- If you press ►/|| while this screen is shown, the system starts program play.

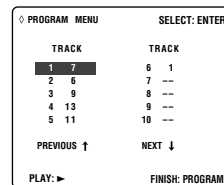

To exit from program play

From the remote control ONLY:

Press PROGRAM.

The PROGRAM MENU screen goes off, and the opening screen appears. (The program you made is still kept in memory.)

- If you press ►/|| while this screen is shown, the unit starts normal playback.



To erase the stored program

Press ▲ to eject the disc.

- If you turn off the system or change the source, the program is also erased.



To check the program contents

You can check the program contents by pressing PROGRAM. The PROGRAM MENU screen appears on the TV screen.

- If you press the button during playback, the program play will stop.



TO BE CONTINUED ON THE NEXT PAGE

VCD/CD Playback

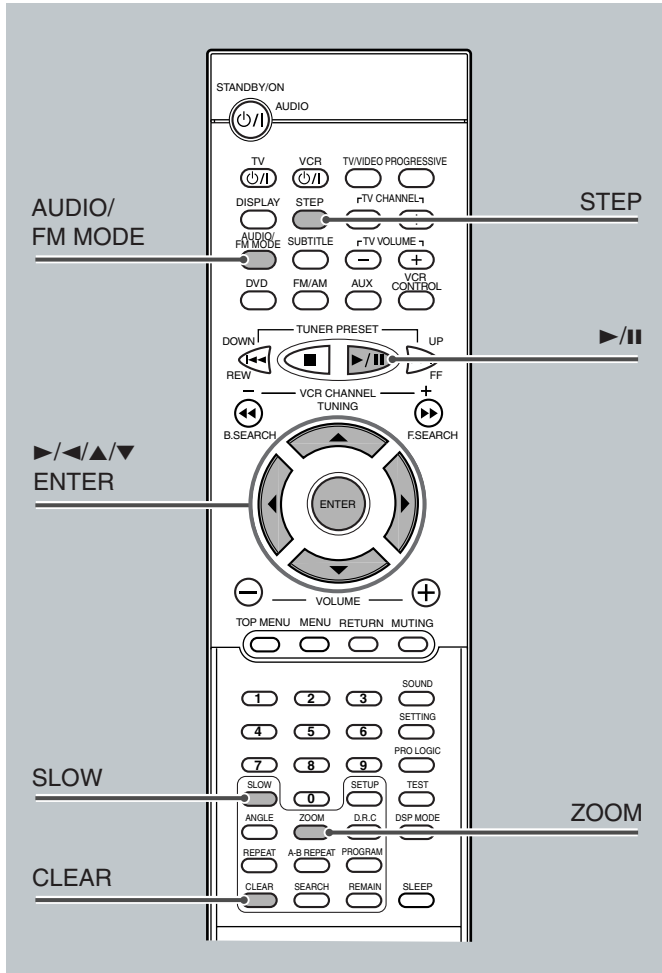

To modify the program

You can modify the program while the PROGRAM MENU screen is shown on the TV screen.

- **To erase a step:** press ▼ (or ▲) to select (highlight) an unwanted program step, then press CLEAR.
- **To modify a step:** press ▼ (or ▲) to select (highlight) a program step you want to modify, then perform steps **3** and **4**. (Before entering a new number, press CLEAR repeatedly until “- -” appears on number entry position.)
- **To add a step:** press ▼ (or ▲) to select (highlight) an empty program step, then perform steps **3** and **4**.

- To move to program step 10 from program step 11, press ▲ when program step 11 is selected (highlighted) so that “PREVIOUS ↑” is selected (highlighted). Then, press ENTER.
- To move to program step 11 from program step 10, press ▼ when program step 10 is selected (highlighted) so that “NEXT ↓” is selected (highlighted). Then, press ENTER.

Selecting Playback Channel

When you play back a karaoke VCD or CD, you can only select either the left channel or right channel to listen to.

Press **AUDIO/FM MODE** repeatedly.

The on-screen bar appears on the screen for a while.

- Each time you press the button, the sound mode changes as follows:

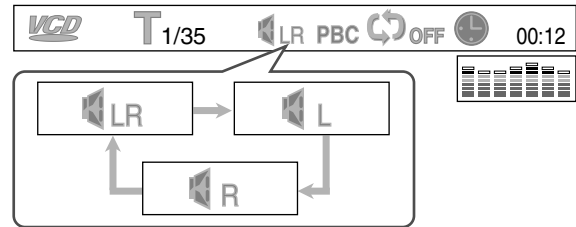
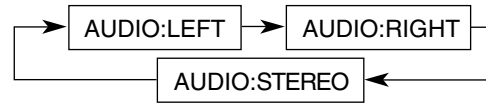

- AUDIO:STEREO (LR)** : Select this to listen to both channel sounds.
- AUDIO:LEFT (L)** : Select this to listen to the left channel sounds.
- AUDIO:RIGHT (R)** : Select this to listen to the right channel sounds.

REMEMBER that after playing back a karaoke VCD or CD using “AUDIO:LEFT” or “AUDIO:RIGHT,” select “AUDIO:STEREO” to restore normal stereo playback.

VCD Special Effect Playback

■ Still Picture/Frame-by-Frame Playback

You can advance the still picture frame by frame while playing a VCD.

From the remote control ONLY:

1 Press STEP once during playback.

A still picture appears on the TV screen.

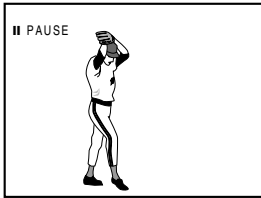

2 Press STEP repeatedly to advance the picture frame by frame.

- Each time you press the button, the picture advances frame by frame.



To resume normal play

Press ►/II.

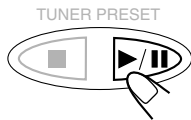

■ Slow Motion Playback

You can enjoy slow motion playback while playing a VCD.

From the remote control ONLY:

Press SLOW repeatedly during playback or pause.

- Each time you press the button, slow motion speed changes as follows:

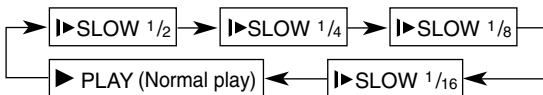

■ Zoom

You can zoom in on the picture while playing a VCD.

From the remote control ONLY:

1 Press ZOOM to zoom in.

- Each time you press the button, the picture is enlarged as follows:

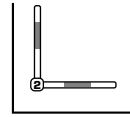

2x Zoom ←→ Canceled

2 Press ►/◀/▲/▼ to move the enlarged portion you want to watch.

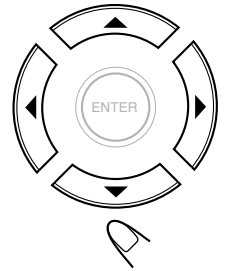
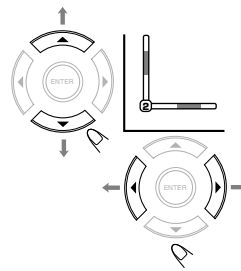

To cancel the ZOOM

Press ZOOM again.

The normal size picture is resumed.



MP3 Introduction

This system is incorporated with an MP3 decoder. You can play back MP3 tracks (files) recorded on CD-Rs, and CD-RWs.

- Notice that “files” and “tracks” are used interchangeably.

What is MP3?

MP3 is an abbreviation of Motion Picture Experts Group (or MPEG) Audio Layer 3. MP3 is simply a file format with a data compression ratio of 1:10 (128 Kbps*). That means, by using MP3 format, one CD-R or CD-RW can contain 10 times as much data volume as a regular CD can.

* Bit rate is the average number of bits that one second of audio data will consume. The measuring unit used is Kbps (1000 bits per second).

To get a better audio quality, choose a higher bit rate. The most popular bit rate for encoding (recording) is 128 Kbps.

MP3 File Compatibility

- This system can only read MP3 files that are recorded in the format that is compliant with ISO 9660 Level 1 or Level 2.
- The system can read or play MP3 files only with the extension code—“.mp3”.
- ID3* tags cannot be shown on the display.
- * An MP3 file can contain file information called “ID3 Tag” where its album name, performer, track title, etc. are recorded. There are two versions—ID3v1 (ID3 Tag version 1) and ID3v2 (ID3 Tag version 2).

Disc structure—How are MP3 files recorded and played back?

“MP3 files (tracks)” can be recorded in “directories (or folders),” in PC terminology.

During recording, the files and directories can be arranged in a way similar to arranging files and folder/directories of computer data.

“Root” is similar to the root of a tree. Every file and directory can be linked to the root.

In compliance with ISO 9660, the maximum allowable depth of nested directories—so-called “hierarchy”—is eight (inclusive of the root).

Playback order, files search order, and directory search order of the MP3 files recorded on a disc are determined by the writing (or encoding) application; therefore, playback order may be different from the one you have intended while recording the folders/directories and the files.

Note on MP3 discs

MP3 discs (either CD-R or CD-RW) require a longer readout time. (It differs due to the complexity of the directory/file configuration.)

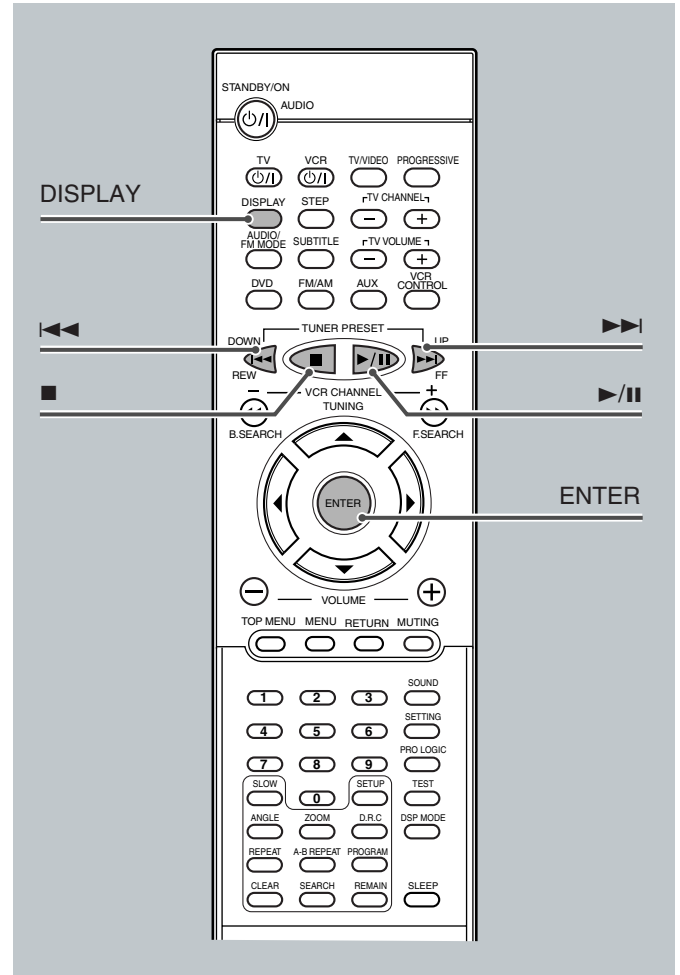

For in-depth information about a disc to be played back, see “Disc Introduction—DVD/VCD/CD” on page 27.

MP3 Playback

Starting Playback

It is recommended to turn on your TV when playing back an MP3 disc.

1 Press **▲** to load a disc.



2 Press **▶/||**.

- After detecting the disc, playback starts.
- The on-screen bar and the contents recorded on the MP3 disc will be shown on the TV if it is turned on.

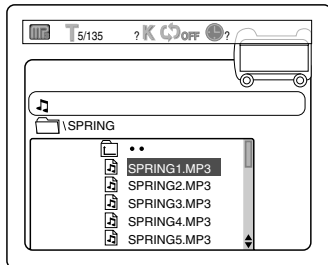
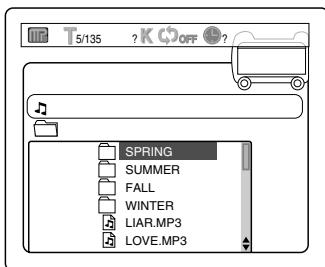

Note:

If the loaded disc is not recorded in the audio CD format or MP3 format, "WRONG DISC FORMAT" appears on the TV screen.

The on-screen bar

①	②	③	④	⑤	⑥
① : Disc type DVD VCD SVCD CD MP3					
② : Current track (file) and total number of the tracks on the disc • Ex.: 1st track is playing out of 35 tracks recorded.					
③ : Bit rate • Ex.: Bit rate used for recording the loaded disc is 128 Kbps. (See the previous page.)					
④ : Repeat mode indicator • Ex.: When repeat mode is turned off. See page 46 for more details.					
⑤ : Elapsed playing time and the total playing time of the current track					
⑥ : Sound indication • Indicates sound input level. (Only appears during playback.)					

To go to another track

Press **▶▶** or **◀◀** during playback.

- ▶▶** : Skip to the beginning of the next track.



- ◀◀** : Skip to the beginning of the previous track.



To stop playback for a moment

Press **▶/||**.

To resume play, press **▶/||** again or **ENTER**.

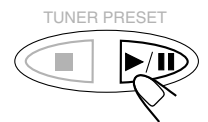

To stop during playback

Press **■**.



To remove the disc

Press **▲** on the front panel.
The disc tray comes out.

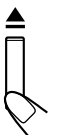

To close the disc tray, press **▲** again.

MP3 Playback

Operations Using the On-Screen Display

It is recommended to turn on your TV when playing back an MP3 disc.

When the loaded MP3 disc is recognized, the following on-screen display appears on the TV screen. (The contents of this on-screen display varies according to the disc—the way MP3 tracks were recorded on the disc.)

- Only the first 8 letters of the titles appear on the TV screen.

From the remote control ONLY:

Button	To do
ENTER	Start playback or go into a directory.
▼ / ▲	Select a track or directory.

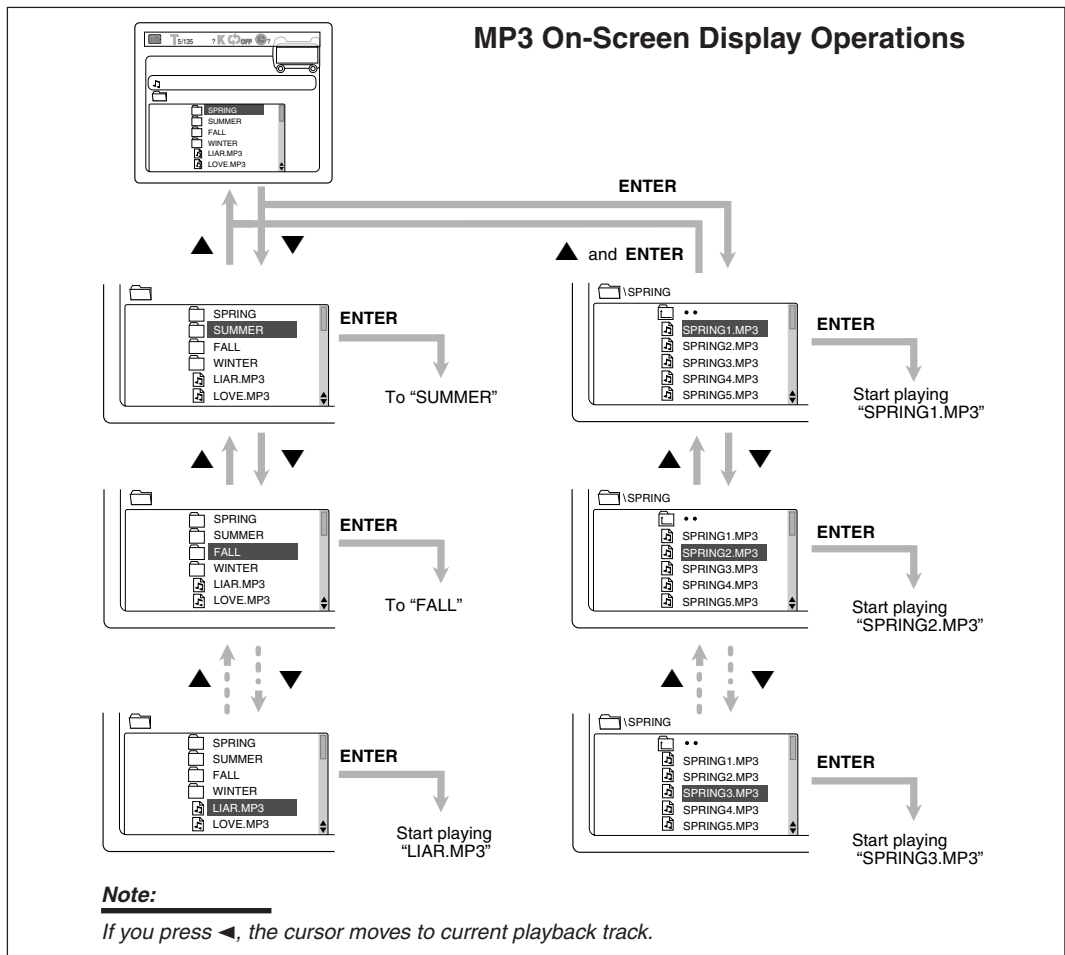
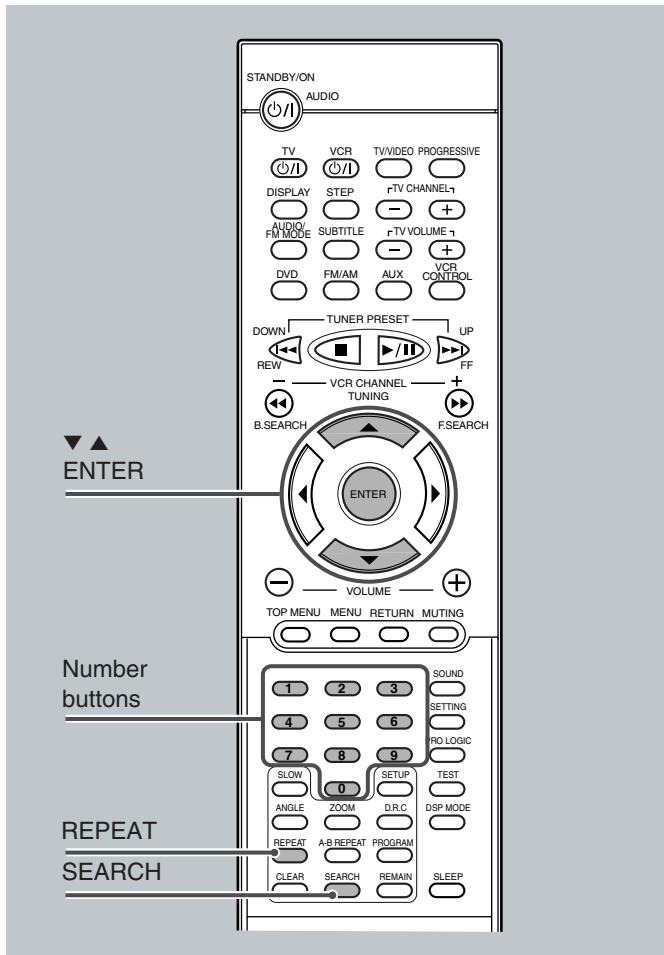

Moving to a Particular Track Directly

You can move to a particular track on the disc directly.

From the remote control ONLY:

1 Press SEARCH during playback or pause.

“TRACK ----” appears on the TV screen.



2 Press the number buttons to select a track number you want.

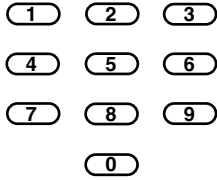

The system starts playback from the selected track.

- To select number 5, press 5 (then ENTER).
- To select number 10, press 1, 0 (then ENTER).
- To select number 23, press 2, 3 (then ENTER).
- To select number 123, press 1, 2, 3.



Note:

When you want to move to another file (track) directly, you can move to it simply by pressing the number buttons (without pressing SEARCH in step 1).

Repeating Playback

On an MP3 disc, A–B Repeat cannot be used. You can enjoy only Repeat play.

To repeat playback—Repeat Play

Press REPEAT repeatedly.

The indication corresponding to the selected mode appears on the TV screen.



- Each time you press the button, repeat mode changes as follows:

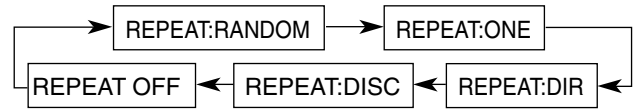

REPEAT:RANDOM

: All tracks recorded on the disc will be played once at random (random play), and random play will be repeated.

REPEAT:ONE

: Current track will be repeated.

REPEAT:DIR

: Tracks in the current directory will be repeated.

REPEAT:DISC

: All tracks on the disc will be repeated.

REPEAT OFF

: Repeat play is canceled. (Normal play is resumed.)

Note:

When the on-screen bar is shown on the TV screen, Repeat mode indication also changes as follows:

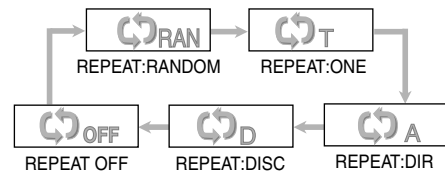

Tuner Operations

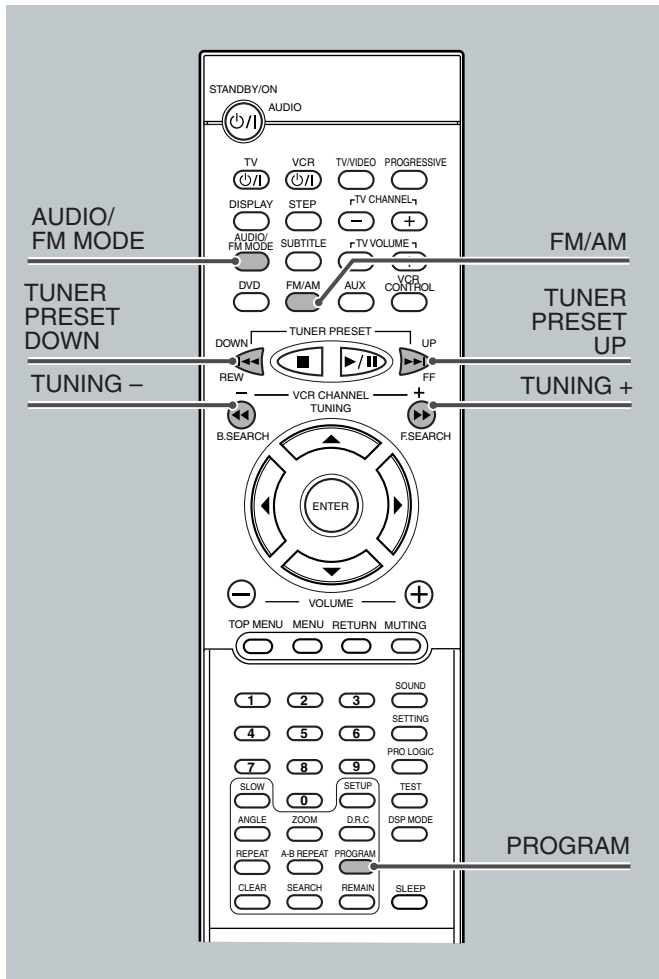

For basic tuner operations, see "Basic Tuner Operations" on page 16.

Tuning in Stations

From the remote control:

1 Press FM/AM repeatedly to select the band.

The last received station of the selected band is tuned in.

- Each time you press the button, the band alternates between FM and AM.



2 Press and hold TUNING + or - until you find the frequency you want.

- TUNING + : Increases the frequency.
- TUNING - : Decreases the frequency.

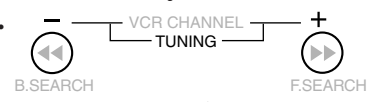

The system starts searching for stations and stops when a station of sufficient signal strength is tuned in.

On the front panel:

1 Press SOURCE repeatedly until the desired band appears on the display.

The last received station of the selected band is tuned in.

- Each time you press the button, the source changes as follows:

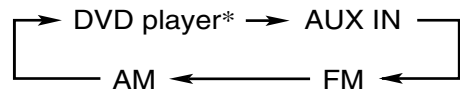

* "WAIT" appears on the display.

2 Press ■ so that "MANUAL" appears on the display.

- Each time you press the button, the operation mode of ►► and ◀◀ buttons alternates between "PRESET" and "MANUAL."



PRESET : Select this for using ►► and ◀◀ as the buttons to select the preset station.

MANUAL : Select this for using ►► and ◀◀ as the buttons to change the frequency manually.

3 Press and hold ►► or ◀◀ until you find the frequency you want.

- ►► : Increases the frequency.
- ◀◀ : Decreases the frequency.



Notes:

- When a station of sufficient signal strength is tuned in, the **TUNED** indicator lights up on the display.
- When an FM stereo program is received, the **ST** indicator also lights up.
- When you press the button repeatedly, the frequency changes step by step.

Using Preset Tuning

Once a station is assigned to a channel number, the station can be quickly tuned. You can preset up to 15 FM and 15 AM stations.

To store the preset stations

From the remote control ONLY:

- 1 Tune in the station you want to preset (see “Tuning in Stations”).

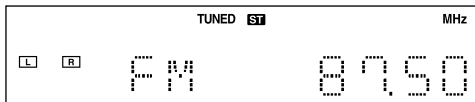

- 2 Press PROGRAM.

The preset number appears on the display and the PROGRAM indicator lights up.

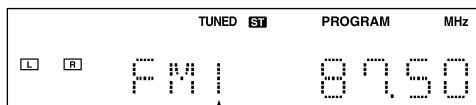

Preset number

- 3 Press TUNER PRESET UP or DOWN to select a preset number.



- TUNER PRESET UP : Increases the preset number.
- TUNER PRESET DOWN : Decreases the preset number.

- 4 Press PROGRAM to store the preset station.

The PROGRAM indicator goes off, and the station is assigned to the selected preset number.



- 5 Repeat steps 1 to 4 until you store all the stations you want.

To erase a stored preset station

Storing a new station on a used number erases the previously stored one.

To tune in a preset station

From the remote control:

- 1 Press FM/AM repeatedly to select the band.



The last received station of the selected band is tuned in.

- Each time you press the button, the band alternates between FM and AM.

- 2 Press TUNER PRESET UP or DOWN until the desired preset station appears on the display.



- TUNER PRESET UP : Increases the preset number.
- TUNER PRESET DOWN : Decreases the preset number.

On the front panel:

- 1 Press SOURCE repeatedly until the desired band appears on the display.



- 2 Press ■ so that “PRESET” appears on the display.



- Each time you press the button, the operation mode of ►► and ◀◀ buttons alternates between “PRESET” and “MANUAL.”

PRESET : Select this for using ►► and ◀◀ as the buttons to select the preset station.

MANUAL : Select this for using ►► and ◀◀ as the buttons to change the frequency manually.

- 3 Press ►► or ◀◀ repeatedly until the desired preset station appears on the display.



- ►► : Increases the preset number.
- ◀◀ : Decreases the preset number.

Selecting the FM Reception Mode

When an stereo FM program tuned currently is noisy, you can change the FM reception mode to improve the reception.

Press AUDIO/FM MODE.

The **ST** indicator goes off from the display and the program loses the stereo effect.



To resume the stereo effect, press AUDIO/FM MODE again. The stereo effect resumes.

Note:

The FM reception mode will also resumes in the following cases:

- When you change the frequency, the preset number, or the band
- When you change the source
- When you turn off the system

Setting up the DVD Preferences

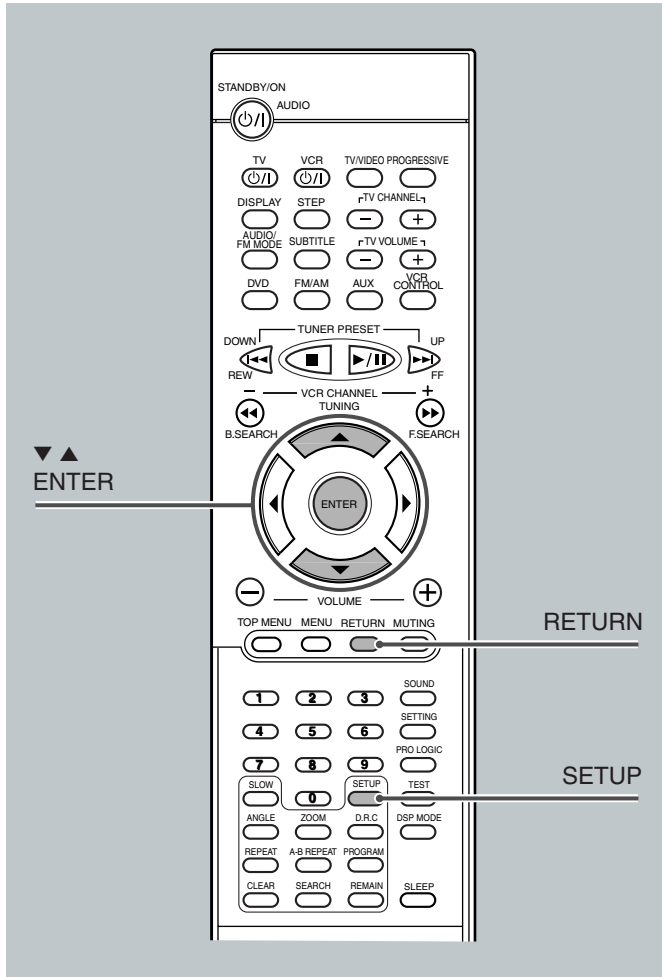

On the Setup menu, you can do the two main important settings—language selection (LANGUAGES) menu and system setting (SYSTEM) menu.

- Setup menu can only be displayed while a disc is not playing. (The DVD player must be selected as the source.)
- You can only use the remote control for Setup menu operations.

Setting the Initial Languages

You can select your favorite language you listen to or read on the TV screen.

When you operate this system or watch a DVD, you will be able to operate the system or to enjoy a DVD in the language you have selected and stored.

On the language selection menu, you can select the following:

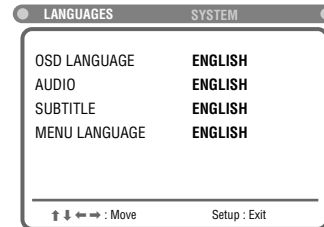

-
- OSD LANGUAGE** : Select the indication language shown on the TV screen while operating the system. (ex. PLAY, STOP, PAUSE, etc.)
-
- AUDIO** : Select the language you listen to while watching a DVD.
-
- SUBTITLE** : Select the subtitle language you read while watching a DVD.
-
- MENU LANGUAGE** : Select the menu language recorded on a DVD which you use while operating the DVD's own menu.
-

Languages you can select on this menu

You can select the following languages separately for each listed item on the menu.

- For “**OSD LANGUAGE**”:
English, Chinese, Spanish, French, German, Japanese, and Korean.
- For “**AUDIO**,” “**SUBTITLE**,” and “**MENU LANGUAGE**”:
English, Chinese, French, German, Japanese, Russian, Spanish, Portuguese, Korean and Original*.

* Available only for “AUDIO” and “SUBTITLE.”

When you want to operate the disc or enjoy its playback in the originally recorded (default) language, select “ORIGINAL.”

Note:

The original language will be selected as the initial language regardless of your setting in the following cases:

- If the language you have selected is not recorded on the disc.
- If the disc is programmed to be played back in the original language.

Basic language selecting procedure

Ex. : To select the desired language as the initial language for "AUDIO."

From the remote control ONLY:

1 Press SETUP.

Language selection menu of the Setup menu appears on the TV screen.

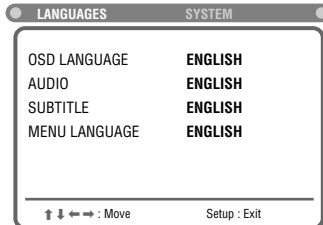

2 Press ▼ (or ▲) to select (highlight) one of the language items.

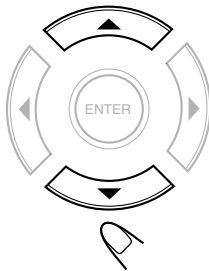
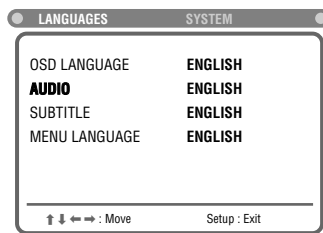

3 Press ENTER.

Pop-up window appears (where the language names are listed).

"✓" indicates the current setting.

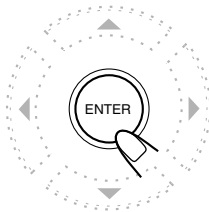
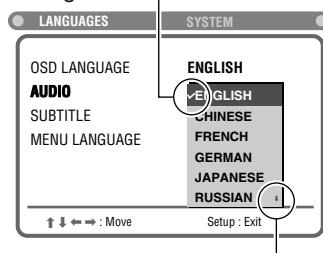

↓ indicates that more languages are listed, but not shown.

4 Press ▼ (or ▲) to select (highlight) the language you want, then press ENTER.

The setting is stored (and the pop-up window goes off).

- When you want to cancel the setting you have just made, press RETURN without pressing ENTER. (Pop-up menu also goes off.)

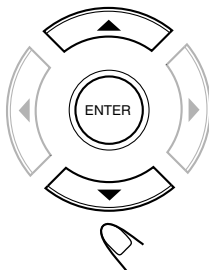

5 Repeat steps 2 to 4 to select the other language items listed.

To erase the Setup menu

Press SETUP.



Introducing the DVD Preference (System)

You can set the DVD preference to match it to your usage and operating circumstances.

On the system setting menu, you can set the following:

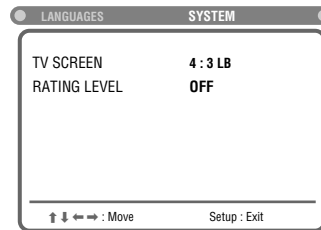

TV SCREEN: Select the TV screen size for playing back a DVD recorded with 16:9 wide screen video signal.

- **4:3 LB** : Select "4:3 LB (Letter Box)" when the aspect ratio of your TV is 4:3. While viewing a wide screen picture, the black bars appear on the top and the bottom of the screen.
- **4:3 PS** : Select "4:3 PS (Pan-Scan)" when the aspect ratio of your TV is 4:3. While viewing a wide screen picture, the black bars do not appear, however, the left and right edge sides of the pictures will not be shown on the screen.
- **16:9** : Select "16:9" when the aspect ratio of the TV is 16:9. (Set the screen size to full on your TV.)

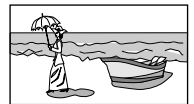
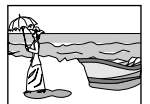

RATING LEVEL: You can select this to restrict playback of DVDs containing violent scenes and those not suitable for your family members. (See page 52 for detailed operations.)

Setting up the DVD Preferences

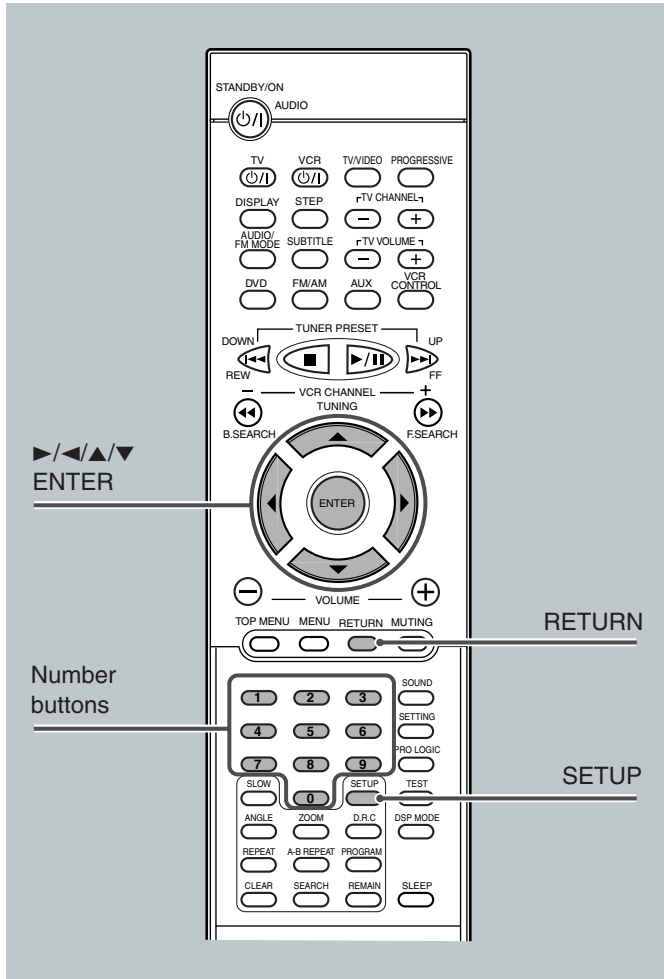

3 Press ▼ (or ▲) to select (highlight) one of the system setting items listed on the menu.

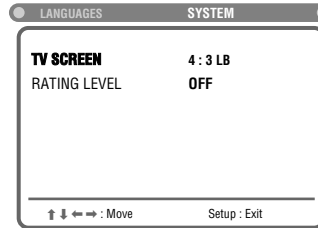
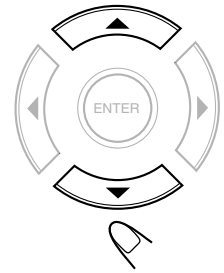

4 Press ENTER.

Pop-up window appears (where the selectable settings are listed).

✓ indicates the current setting.

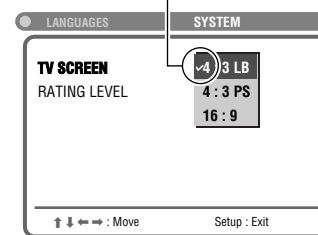
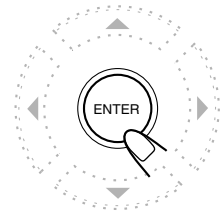

5 Press ▼ (or ▲) to select (highlight) the proper setting, then press ENTER.

The setting is stored (and the pop-up window goes off).

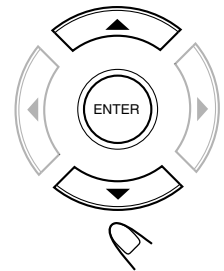

Setting the TV screen size

From the remote control ONLY:

1 Press SETUP.

Language selection menu of the setup menu appears on the TV screen.

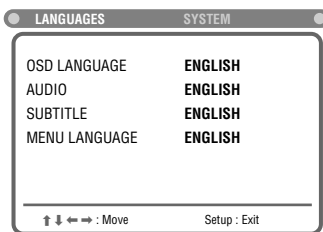

2 Press ENTER (or ►/◀) to select (highlight) the system setting menu.

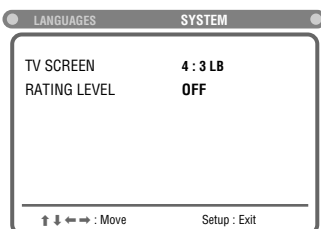
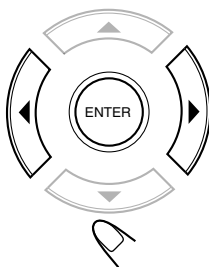

- When you want to cancel the setting you have just made, press RETURN without pressing ENTER. (Pop-up menu also goes off.)

- Even if "4:3 PS" is selected, the screen size may become "4:3 LB" while playing some DVDs. This depends on how the DVD is programmed and recorded.
- If a disc (or some portions of the disc) is recorded with the video signals of 4:3 aspect ratio, this setting does not take effect. The pictures are displayed with full 4:3 aspect ratio or with 4:3 Letter Box.

To erase the Setup menu

Press SETUP.



Setting the Parental (Rating) Level

Using this function, you can restrict playback of DVD containing violent scenes and those not suitable for your family members. Nobody can play such a disc unless this function is canceled. (“WRONG PARENTAL CODE” appears on the display if you try to play back such a disc.)

- This setting takes effect only for the DVDs containing the rating level information—Level 1 (most restrictive) to Level 8 (least restrictive).

From the remote control ONLY:

1 Press SETUP.

Language selection menu of the setup menu appears on the TV screen.



2 Press ENTER (or ►/◀) to select (highlight) the system setting menu.

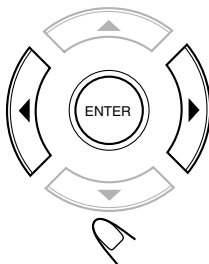
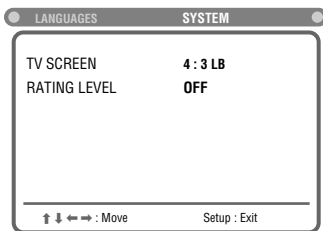

3 Press ▼ (or ▲) to select (highlight) “RATING LEVEL.”

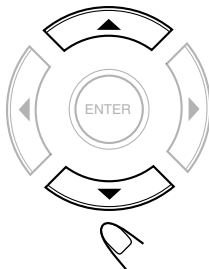
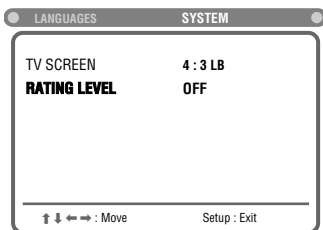

4 Press ENTER.

“RATING LEVEL” now changes to “ENTER PASSWORD” on the menu.

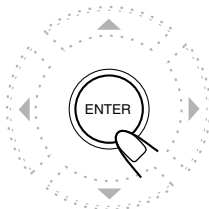
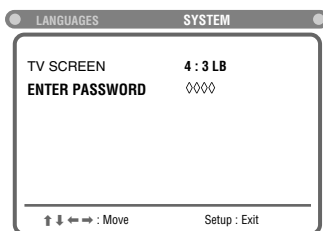

5 Press the number buttons to enter the password (4 digits).

- When shipped from the factory, password is “7890.”
- If you enter a wrong password, your setting will be canceled.

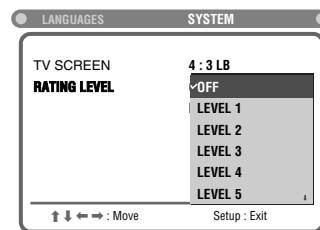
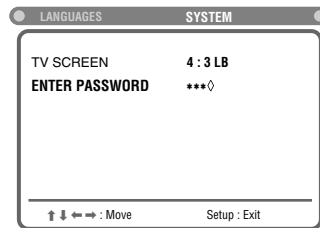

6 Press ▼ (or ▲) to select (highlight) the level you want, then press ENTER.

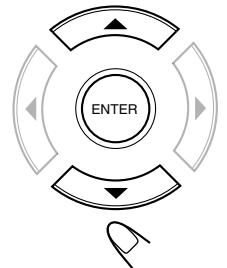

To erase the Setup menu

Press SETUP again.



Setting up the DVD Preferences

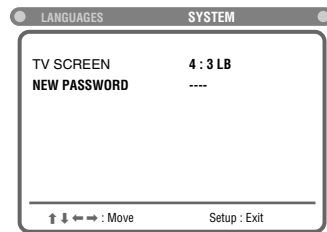
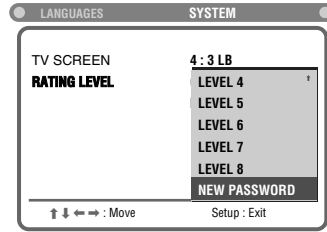
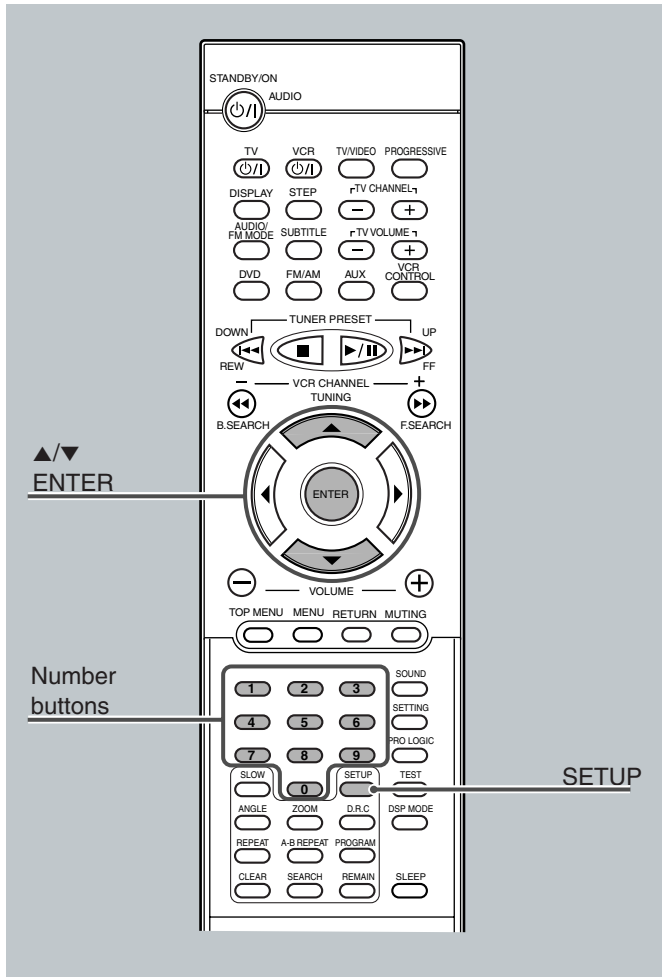

- If “NEW PASSWORD” is the last item listed on the pop-up window and is not shown, pressing ▼ repeatedly will show it in the pop-up window.

3 Press the number buttons to enter a new password, then ENTER.

Your new password is now stored.

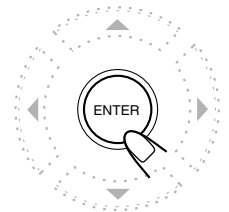

To change the password

1 Repeat steps 1 to 5 of “Setting the Parental (Rating) Level” procedure.

2 Press ▼ (or ▲) to select (highlight) “NEW PASSWORD,” then ENTER.

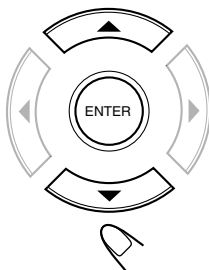

To erase the Setup menu

Press SETUP again.



To reset the password

You can reset the password to the initial setting “7890.”

REMEMBER all the other preset settings such as the speaker settings, preset stations, timer settings, DVD setup menu settings are also reset to the factory settings.

While the source is DVD player and playback stops, press and hold ■ on the front panel until the “INITIAL” appears on the display.

Operating JVC's Components

You can use the remote control to operate not only this unit but also other JVC products.

- Refer also to the manuals supplied for the other products.
 - This remote control can operate a VCR whose remote control code is set to A code.
- To operate the other products, aim the remote control directly at the remote sensor on the target product.

❑ To operate a JVC's TV

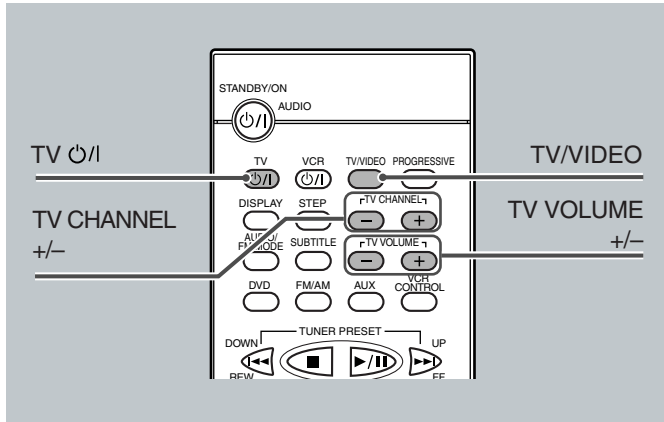

You can perform the following operations on the TV.

TV \odot/I	: Turn on or off the TV.
TV VOLUME +/-	: Adjust the volume.
TV/VIDEO	: Set the input mode (either TV or VIDEO).
TV CHANNEL +/-	: Change the channels.

❑ To operate a JVC's VCR

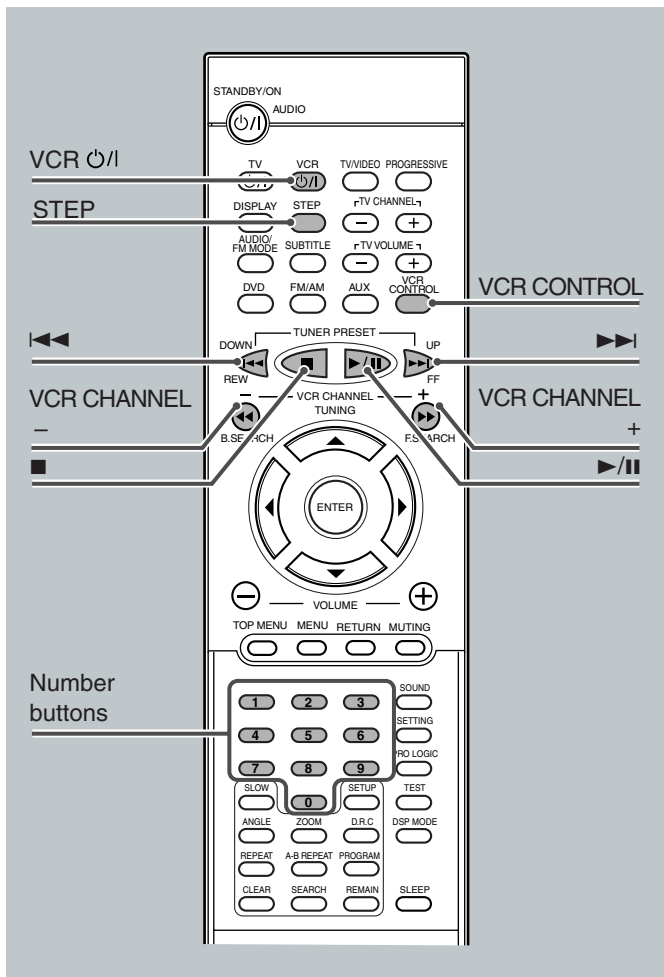

After pressing **VCR CONTROL** on the remote control, you can perform the following operations on the VCR.



VCR \odot/I	: Turn on or off the VCR.
VCR CHANNEL +/-	: Change the channels.
1 - 9, 0	: Select TV channel on the VCR.
▶/II	: Start playback.
■	: Stop playback.
STEP	: Pause playback. To release it, press ▶/II.
FF (▶▶)	: Fast-wind a tape.
REW (◀◀)	: Rewind a tape.

After operating the VCR, press **DVD** or **FM/AM**.



IMPORTANT:

When you press **VCR CONTROL**, some buttons on the remote control cannot work for operating this unit.

To operate this unit, press **DVD** or **FM/AM**.

Operating Other Manufacturers' TV

You can use the remote control to operate other manufacturers' TV.

- Refer also to the manuals supplied for the other products.
- To operate the other products, aim the remote control directly at the remote sensor on the target product.

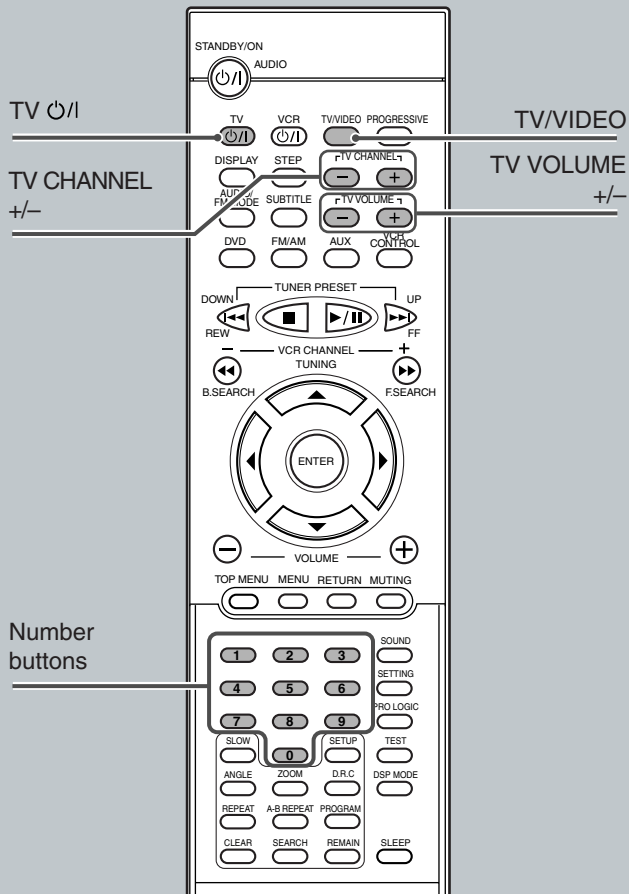

To change the transmittable signals for operating a TV

1. Press and hold TV ON/OFF.
2. Enter manufacturer's code using buttons 1-9, and 0.
3. Release TV ON/OFF.

Now, you can perform the following operations on the TV.

TV ON/OFF	: Turn on or off the TV.
TV VOLUME +/-	: Adjust the volume.
TV/VIDEO	: Set the input mode (either TV or VIDEO)
TV CHANNEL +/-	: Change the channels.

4. Try to operate your TV by pressing TV ON/OFF.
When your TV turns on or off, you have entered the correct code.

If there are more than one code listed for your brand of TV, try each one until the correct one is entered.

Manufacturers' codes for TV

Manufacturer	Codes
JVC	01
Hitachi	10
Magnavox	04
Mitsubishi	13
Panasonic	12, 24
RCA	07, 29
Samsung	11
Sanyo	05, 20
Sharp	02, 16, 22
Sony	03
Toshiba	09
Zenith	17

Manufacturers' codes are subject to change without notice. If they are changed, this remote control cannot operate the equipment.

Maintenance

To get the best performance of the unit, keep your discs and mechanism clean.

General Notes

In general, you will have the best performance by keeping your discs, and the mechanism clean.

- Store discs in their cases, and keep them in cabinets or on shelves.
- Keep the disc tray closed when not in use.

Handling Discs



- Remove the disc from its case by holding it at the edge while pressing the center hole lightly.
- Do not touch the shiny surface of the disc, or bend the disc.
- Put the disc back in its case after use to prevent warping.

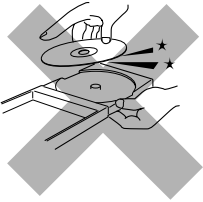

- Be careful not to scratch the surface of the disc when placing it back in its case.
- Avoid exposure to direct sunlight, temperature extremes, and moisture.



To clean the disc

Wipe the disc with a soft cloth in a straight line from center to edge.

DO NOT use any solvent—such as conventional record cleaner, spray, thinner, or benzine—to clean the disc.

Cleaning the unit

• Stains on the unit

Should be wiped off with a soft cloth. If the unit is heavily stained, wipe it with a cloth soaked in water-diluted neutral detergent and wrung well, then wipe clean with a dry cloth.

• Since the unit may deteriorate in quality, become damaged or get its paint peeled off, be careful about the following.

- DO NOT wipe it with a hard cloth.
- DO NOT wipe it strong.
- DO NOT wipe it with thinner or benzine.
- DO NOT apply any volatile substance such as insecticides to it.
- DO NOT allow any rubber or plastic to remain in contact with it for a long time.

Troubleshooting

Use this chart to help you solve daily operational problems. If there is any problem you cannot solve, contact your JVC service center.

PROBLEM	POSSIBLE CAUSE	SOLUTION
Power does not come on.	The power cord is not connected correctly.	Insert the plug into the socket.
The remote control does not work.	<ul style="list-style-type: none"> • It is too far from the center unit, or is not facing the center unit. • There is something obstructing the remote sensor. • The VCR CONTROL button has been pressed. • The battery is flat. • The battery has been inserted the wrong way round (+/-). • Sunlight is falling directly on the detector. 	<ul style="list-style-type: none"> • Come close to the center unit. • Avoid any obstacles. • Press DVD or FM/AM to operate the system. (See page 54.) • Replace the battery. • Insert the battery correctly. • Shade the remote control from direct sunlight.
No sound.	<ul style="list-style-type: none"> • There is a short in the speaker cord. • The audio cord is not connected properly. • An incorrect source has been selected. • Muting is on. • The disc is copy-protected CD. 	<ul style="list-style-type: none"> • Reconnect the speaker cord. • Connect the cord properly. (See page 9.) • Select the correct source. (See pages 12 to 17.) • Press MUTING to cancel muting. • Replace the disc.
Sound is emitted from only one speaker.	<ul style="list-style-type: none"> • The speaker cord is not connected correctly. • Left-right balance is incorrect. 	<ul style="list-style-type: none"> • Connect the cord properly. (See page 8.) • Adjust balance. (See pages 22 to 26.)
No video.	<ul style="list-style-type: none"> • The video cord is not connected properly. • TV input selection is incorrect. 	<ul style="list-style-type: none"> • Connect the cord properly. (See page 10.) • Select the correct input.
No picture is displayed on the TV screen, the picture is blurred, or the picture is divided into two parts.	<ul style="list-style-type: none"> • The scan mode is set to "P-SCAN MODE" though the system is connected to the TV which does not support the progressive video input such as a conventional TV. 	<ul style="list-style-type: none"> • Change the scan mode to "I-SCAN MODE." (See page 11.)
A disc cannot be played.	<ul style="list-style-type: none"> • The system and disc region code numbers are incompatible. • The disc causes the parental (rating) error. 	<ul style="list-style-type: none"> • Replace the disc. (See page 27.) • Enter password to change the parental (rating) level. (See page 52.)
"WRONG DISC FORMAT" appears on the TV screen.	<ul style="list-style-type: none"> • The disc is recorded with color system of PAL. • The CD-R/CD-RW does not contain any MP3 files. 	<ul style="list-style-type: none"> • Replace the disc. (See page 27.) • Replace the disc.
Pictures and sounds are distorted.	<ul style="list-style-type: none"> • The disc is dirty. • A VCR is connected between the center unit and the TV. 	<ul style="list-style-type: none"> • Clean the disc. • Connect the center unit and TV directly.
Pictures are distorted when progressive mode is selected.	<ul style="list-style-type: none"> • "Progressive Mode" may not be set appropriately for the current disc. 	<ul style="list-style-type: none"> • Change "Progressive Mode" (See page 17.)
The edge is missing on the picture image.	<ul style="list-style-type: none"> • Initial setup (TV screen size) was incorrect. 	<ul style="list-style-type: none"> • Set TV screen size correctly. (See pages 50 and 51.)
Continuous static during FM broadcasts.	<ul style="list-style-type: none"> • The received signal is too weak. • The station is too far away. • The antenna is not connected correctly. 	<ul style="list-style-type: none"> • Connect an external FM antenna (see page 6), or contact your dealer. • Select another station. • Check the connection. (See page 6.)
The system does not work correctly.	<ul style="list-style-type: none"> • Lightning or electronic noise interferes with operation of the microcomputer. • Immediately after heating the room, the unit was moved to a cold location causing condensation to form inside. 	<ul style="list-style-type: none"> • Switch power off, and remove and re-insert the power plug in the socket. • Turn off the power, plug off and leave the unit a few hours before switching power on again.
The VCR cannot be operated using this remote control.	<ul style="list-style-type: none"> • The remote control is not set for VCR operations. • The VCR is not a JVC's product. 	<ul style="list-style-type: none"> • Press VCR CONTROL to operate the VCR. (See page 54.) • This remote control can operate a JVC's VCR whose remote control code is set to A code.

Specifications

Center unit (XV-THA30)

Amplifier section

Front/Center/Rear:

25 watts per channel, min. RMS at 6 ohms as 1 kHz, with no more than 10 % total harmonic distortion.

Subwoofer:

110 watts per channel, min. RMS at 4 ohms as 100 Hz, with no more than 10 % total harmonic distortion.

Audio section

Audio input sensitivity/Impedance (at 1 kHz)

AUX IN: 500 mV/47 k Ω

Video section

Color System: NTSC

Horizontal Resolution: 480 lines

Signal-to-Noise Ratio: 68 dB

Output Level VIDEO OUT

VIDEO (Composite): 1.0 V(p-p)/75 Ω

S-VIDEO (Y): 1.0 V(p-p)/75 Ω

(C): 0.286 V(p-p)/75 Ω

COMPONENT OUT

Y: 1.0 V(p-p)/75 Ω

PB/PR: 0.7 V(p-p)/75 Ω

Tuner section

Tuning Range FM : 87.5 MHz – 108.0 MHz

AM : 530 kHz – 1 710 kHz

Usable Sensitivity FM: 8.0 dBf (0.9 μ V/75 Ω)

AM loop antenna: 650 μ V/m

General

Readable discs: DVD VIDEO, Video CD, Super Video CD, Audio CD, CD-R/RW (Audio CD, Video CD, Super Video CD, MP3 disc), DVD-R (Video format)

Power Requirements: AC 120 V \sim , 60 Hz

Power Consumption: 120 W (at operation)
2 W (in standby mode)

Dimensions (W \times H \times D): 350 mm \times 80 mm \times 365 mm
(13 ¹³/₁₆ in. \times 3 ³/₁₆ in. \times 14 ³/₈ in.)

Mass: 6.5 kg (14.4 lbs)

Subwoofer (SP-WA30)

Speaker: 20 cm
Bass-reflex, Magnetically Shielded

Power Handling Capacity: 110 W

Impedance: 4 Ω (min)

Frequency Range: 25 Hz to 200 Hz

Dimensions (W \times H \times D): 249 mm \times 404 mm \times 335 mm
(9 ¹³/₁₆ in. \times 15 ¹⁵/₁₆ in. \times 13 ¹/₄ in.)

Mass: 6.5 kg (14.4 lbs) (except cords)

Satellite Speakers (SP-XA30)

Speakers: 8 cm
Bass-reflex, Magnetically Shielded

Power Handling Capacity: 25 W

Impedance: 6 Ω (min)

Frequency Range: 90 Hz to 20 kHz

Length of cords: 6 m

Dimensions (W \times H \times D): 105 mm \times 119 mm \times 126 mm
(4 ³/₁₆ in. \times 4 ¹¹/₁₆ in. \times 5 in.)

Mass: 600 g (1.4 lbs) (except cords)

Rear Satellite Speakers (SP-XSA30)

Speakers: 8 cm
Bass-reflex, Magnetically Shielded

Power Handling Capacity: 25 W

Impedance: 6 Ω (min)

Frequency Range: 90 Hz to 20 kHz

Length of cords: 10 m

Dimensions (W \times H \times D): 105 mm \times 119 mm \times 126 mm
(4 ³/₁₆ in. \times 4 ¹¹/₁₆ in. \times 5 in.)

Mass: 600 g (1.4 lbs) (except cords)

Designs & specifications are subject to change without notice.



LIMITED WARRANTY

CONSUMER VIDEO 1-90

JVC COMPANY OF AMERICA warrants this product and all parts thereof, except as set forth below ONLY TO THE ORIGINAL PURCHASER AT RETAIL to be FREE FROM DEFECTIVE MATERIALS AND WORKMANSHIP from the date of original retail purchase for the period as shown below. ("The Warranty Period")

PARTS	1 YR	LABOR	90 DAYS
-------	-------------	-------	----------------

THIS LIMITED WARRANTY IS VALID ONLY IN THE FIFTY (50) UNITED STATES, THE DISTRICT OF COLUMBIA AND IN COMMONWEALTH OF PUERTO RICO.

WHAT WE WILL DO:

If this product is found to be defective, JVC will repair or replace defective parts at no charge to the original owner. Such repair and replacement services shall be rendered by JVC during normal business hours at JVC authorized service centers. Parts used for replacement are warranted only for the remainder of the Warranty Period. All products and parts thereof may be brought to a JVC authorized service center on a carry-in basis except for Television sets having a screen size 25 inches and above which are covered on an in-home basis.

WHAT YOU MUST DO FOR WARRANTY SERVICE:

Return your product to a JVC authorized service center with a copy of your bill of sale. For your nearest JVC authorized service center, please call toll free: (800) 537-5722.

If service is not available locally, box the product carefully, preferably in the original carton, and ship, insured, with a copy of your bill of sale plus a letter of explanation of the problem to the nearest JVC Factory Service Center, the name and location of which will be given to you by the toll-free number.

If you have any questions concerning your JVC Product, please contact our Customer Relations Department.

WHAT IS NOT COVERED:

This limited warranty provided by JVC does not cover:

1. Products which have been subject to abuse, accident, alteration, modification, tampering, negligence, misuse, faulty installation, lack of reasonable care, or if repaired or serviced by anyone other than a service facility authorized by JVC to render such service, or if affixed to any attachment not provided with the products, or if the model number or serial number has been altered, tampered with, defaced or removed;
2. Initial installation and installation and removal for repair;
3. Operational adjustments covered in the Owner's Manual, normal maintenance, video and audio head cleaning;
4. Damage that occurs in shipment, due to act of God, and cosmetic damage;
5. Signal reception problems and failures due to line power surge;
6. Video Pick-up Tubes/CCD Image Sensor, Cartridge, Stylus (Needle) are covered for 90 days from the date of purchase;
7. Accessories;
8. Batteries (except that Rechargeable Batteries are covered for 90 days from the date of purchase);

There are no express warranties except as listed above.

THE DURATION OF ANY IMPLIED WARRANTIES, INCLUDING THE IMPLIED WARRANTY OF MERCHANTABILITY, IS LIMITED TO THE DURATION OF THE EXPRESS WARRANTY HEREIN.

JVC SHALL NOT BE LIABLE FOR THE LOSS OF USE OF THE PRODUCT, INCONVENIENCE, LOSS OR ANY OTHER DAMAGES, WHETHER DIRECT, INCIDENTAL OR CONSEQUENTIAL (INCLUDING, WITHOUT LIMITATION, DAMAGE TO TAPES, RECORDS OR DISCS) RESULTING FROM THE USE OF THIS PRODUCT, OR ARISING OUT OF ANY BREACH OF THIS WARRANTY. ALL EXPRESS AND IMPLIED WARRANTIES, INCLUDING THE WARRANTIES OF MERCHANTABILITY AND FITNESS FOR PARTICULAR PURPOSE, ARE LIMITED TO THE WARRANTY PERIOD SET FORTH ABOVE.

Some states do not allow the exclusion of incidental or consequential damages or limitations on how long an implied warranty lasts, so these limitations or exclusions may not apply to you. This warranty gives you specific legal rights and you may also have other rights which vary from state to state.

JVC COMPANY OF AMERICA 1700 Valley Road
 DIVISION OF JVC AMERICAS CORP. Wayne, NJ 07470

REFURBISHED PRODUCTS CARRY A SEPARATE WARRANTY, THIS WARRANTY DOES NOT APPLY. FOR DETAILS OF REFURBISHED PRODUCT WARRANTY, PLEASE REFER TO THE REFURBISHED PRODUCT WARRANTY INFORMATION PACKAGED WITH EACH REFURBISHED PRODUCT.

For customer use:

Enter below the Model No. which is located either on the rear, bottom or side of the cabinet. Retain this information for future reference.

Model No. :	Serial No. :
Purchase data :	Name of dealer :

Authorized Service Centers

QUALITY **JVC**[®] SERVICE

HOW TO LOCATE YOUR JVC SERVICE CENTER

TOLL FREE: 1 (800) 537-5722

<http://www.jvc.com>

Dear Customer,

In order to receive the most satisfaction from your purchase, please read the instruction booklet before operating the unit. In the event that repairs are necessary, please call 1 (800)537-5722 for your nearest authorized servicer or visit our website at **www.JVC.com**

Remember to retain your Bill of Sale for Warranty Service.

Do not service the television yourself

Caution

To prevent electrical shock, do not open the cabinet. There are no user serviceable parts inside. Please refer to qualified service personnel for repairs.

Accessories

To purchase accessories for your JVC product, please call toll free: 1 (800)882-2345 or on the web at **www.JVC.com**

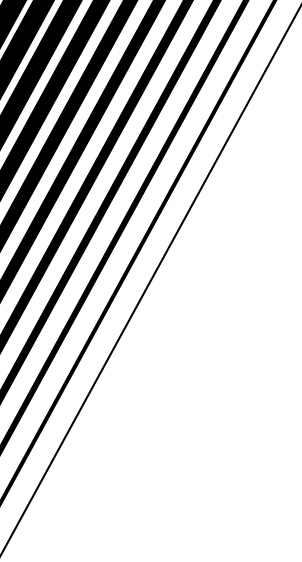

JVC
VICTOR COMPANY OF JAPAN, LIMITED

JVC



DVD DIGITAL THEATER SYSTEM SYSTÈME CINÈMA NUMÉRIQUE DVD

TH-A30

Consists of XV-THA30, SP-WA30, SP-XA30 and SP-XSA30
Se compose de XV-THA30, SP-WA30, SP-XA30 et SP-XSA30

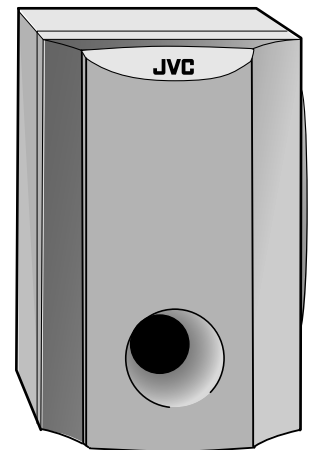
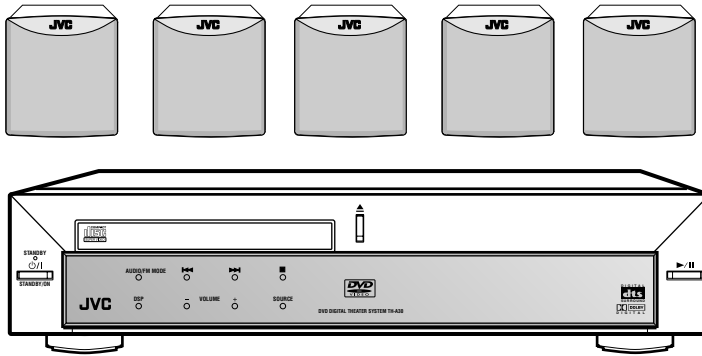

INSTRUCTIONS MANUEL D'INSTRUCTIONS

For Customer Use:

Enter below the Model No. and Serial No. which are located either on the rear, bottom or side of the cabinet. Retain this information for future reference.

Model No. _____

Serial No. _____

LVT0945-003A

[C]

Warnings, Cautions and Others/ Mises en garde, précautions et indications diverses

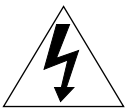

The lightning flash with arrowhead symbol, within an equilateral triangle is intended to alert the user to the presence of uninsulated "dangerous voltage" within the product's enclosure that may be of sufficient magnitude to constitute a risk of electric shock to persons.



The exclamation point within an equilateral triangle is intended to alert the user to the presence of important operating and maintenance (servicing) instructions in the literature accompanying the appliance.

WARNING: TO REDUCE THE RISK OF FIRE OR ELECTRIC SHOCK, DO NOT EXPOSE THIS APPLIANCE TO RAIN OR MOISTURE.

CAUTION

To reduce the risk of electrical shocks, fire, etc.:

1. Do not remove screws, covers or cabinet.
2. Do not expose this appliance to rain or moisture.

ATTENTION

Afin d'éviter tout risque d'électrocution, d'incendie, etc.:

1. Ne pas enlever les vis ni les panneaux et ne pas ouvrir le coffret de l'appareil.
2. Ne pas exposer l'appareil à la pluie ni à l'humidité.

Caution—STANDBY/ON switch!

Disconnect the mains plug to shut the power off completely. The STANDBY/ON  switch in any position does not disconnect the mains line. The power can be remote controlled.

Attention — Commutateur STANDBY/ON !

Déconnecter la fiche de secteur pour couper complètement le courant. Le commutateur STANDBY/ON  ne coupe jamais complètement la ligne de secteur, quelle que soit sa position. Le courant peut être télécommandé.

Note to CATV system installer:

This reminder is provided to call the CATV system installer's attention to Section 820-40 of the NEC which provides guidelines for proper grounding and, in particular, specifies that the cable ground shall be connected to the grounding system of the building, as close to the point of cable entry as practical.

For U.S.A.

This equipment has been tested and found to comply with the limits for a Class B digital device, pursuant to part 15 of the FCC Rules. These limits are designed to provide reasonable protection against harmful interference in a residential installation.

This equipment generates, uses and can radiate radio frequency energy and, if not installed and used in accordance with the instructions, may cause harmful interference to radio communications. However, there is no guarantee that interference will not occur in a particular installation. If this equipment does cause harmful interference to radio or television reception, which can be determined by turning the equipment off and on, the user is encouraged to try to correct the interference by one or more of the following measures:

Reorient or relocate the receiving antenna.

Increase the separation between the equipment and receiver.

Connect the equipment into an outlet on a circuit different from that to which the receiver is connected.

Consult the dealer or an experienced radio/TV technician for help.

For Canada/pour le Canada

CAUTION: TO PREVENT ELECTRIC SHOCK, MATCH WIDE BLADE OF PLUG TO WIDE SLOT, FULLY INSERT

ATTENTION: POUR EVITER LES CHOCS ELECTRIQUES, INTRODUIRE LA LAME LA PLUS LARGE DE LA FICHE DANS LA BORNE CORRESPONDANTE DE LA PRISE ET POUSSER JUSQU'AU FOND

For Canada/pour Le Canada

THIS DIGITAL APPARATUS DOES NOT EXCEED THE CLASS B LIMITS FOR RADIO NOISE EMISSIONS FROM DIGITAL APPARATUS AS SET OUT IN THE INTERFERENCE-CAUSING EQUIPMENT STANDARD ENTITLED "DIGITAL APPARATUS," ICES-003 OF THE DEPARTMENT OF COMMUNICATIONS. CET APPAREIL NUMERIQUE RESPECTE LES LIMITES DE BRUITS RADIOELECTRIQUES APPLICABLES AUX APPAREILS NUMERIQUES DE CLASSE B PRESCRITES DANS LA NORME SUR LE MATERIEL BROUILLEUR; "APPAREILS NUMERIQUES", NMB-003 EDICTEE PAR LE MINISTRE DES COMMUNICATIONS.

IMPORTANT FOR LASER PRODUCTS

1. CLASS 1 LASER PRODUCT
2. **CAUTION:** Invisible laser radiation when open and interlock failed or defeated. Avoid direct exposure to beam.
3. **CAUTION:** Do not open the top cover. There are no user serviceable parts inside the Unit; leave all servicing to qualified service personnel.

1. PRODUIT LASER CLASSE 1
2. **ATTENTION:** Radiation laser invisible quand l'appareil est ouvert ou que le verrouillage est en panne ou désactivé. Éviter une exposition directe au rayon.
3. **ATTENTION:** Ne pas ouvrir le couvercle du dessus. Il n'y a aucune pièce utilisable à l'intérieur. Laisser à un personnel qualifié le soin de réparer votre appareil

Caution: Proper Ventilation

To avoid risk of electric shock and fire and to protect from damage.

Locate the apparatus as follows:

- Front: No obstructions open spacing.
 Sides: No obstructions in 10 cm from the sides.
 Top: No obstructions in 10 cm from the top.
 Back: No obstructions in 15 cm from the back
 Bottom: No obstructions, place on the level surface.

In addition, maintain the best possible air circulation as illustrated.

Attention: Ventilation Correcte

Pour éviter les chocs électriques, l'incendie et tout autre dégât.

Disposer l'appareil en tenant compte des impératifs suivants

- Avant: Rien ne doit gêner le dégagement
 Flancs: Laisser 10 cm de dégagement latéral
 Dessus: Laisser 10 cm de dégagement supérieur
 Arrière: Laisser 15 cm de dégagement arrière
 Dessous: Rien ne doit obstruer par dessous; poser l'appareil sur une surface plate.

Veiller également à ce que l'air circule le mieux possible comme illustré.

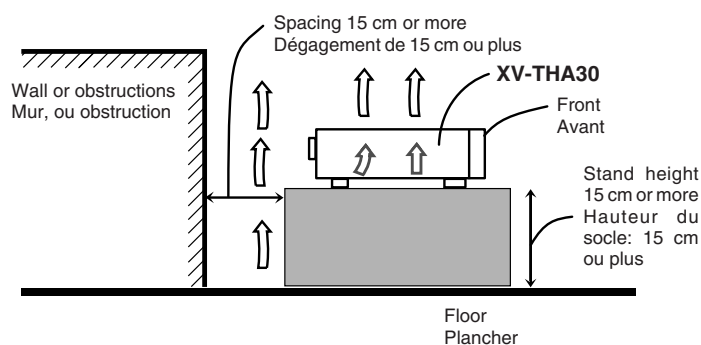
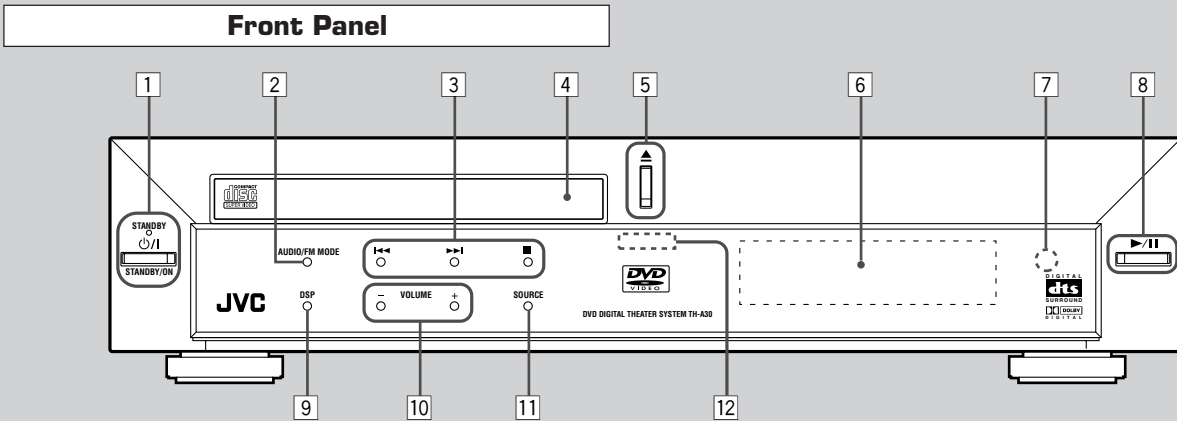

Table of Contents

Parts Identification	2	Basic Disc Operations	28
Center Unit	2	DVD Playback	29
Remote Control	3	Showing the On-Screen Bar	29
Getting Started	5	Selecting the Subtitles	30
Before Installation	5	Selecting the Audio Languages	30
Checking the Supplied Accessories	5	Selecting the Multi-Angle Views	30
Putting Batteries in the Remote Control	5	Checking the Remaining Time	31
Connecting the FM and AM Antennas	6	Disc Menu-Driven Playback	31
Speaker Layout Diagram	7	Moving to a Particular Portion Directly	32
Connecting the Speakers	8	Searching for a Particular Point	32
Connecting Audio/Video Component	9	Repeating Playback	33
TV Preparation	11	■ Repeat Play	33
Changing the Scan Mode	11	■ A-B Repeat	33
Basic DVD Operations	12	Programming the Playing Order of the Chapters	
1 Turn On the Power	12	—Program Play	34
2 Selecting the source	12	DVD Special Effect Playback	36
3 Load a DVD	12	■ Still Picture/Frame-by-Frame Playback	36
4 Start Playback	12	■ Slow Motion Playback	36
5 Adjust the Volume	12	■ Zoom	36
6 Select an Appropriate Progressive Mode	13	VCD/CD Playback	37
7 Activate Surround or DSP Mode	13	Showing the On-Screen Bar	37
8 Stop Playback	13	Checking the Remaining Time	37
Basic VCD/CD Operations	14	Disc Menu-Driven Playback (Only for VCD)	38
1 Turn On the Power	14	Moving to a Particular Portion Directly	38
2 Selecting the source	12	Searching for a Particular Point	38
3 Load a VCD/CD	14	Repeating Playback	39
4 Start Playback	14	■ Repeat Play	39
5 Adjust the Volume	15	■ A-B Repeat	39
6 Activate DSP Mode	15	Programming the Playing Order of the Tracks	
7 Stop Playback	15	—Program Play	40
Basic Tuner Operations	16	Selecting Playback Channel	41
1 Turn On the Power	16	VCD Special Effect Playback	42
2 Select the Band	16	■ Still Picture/Frame-by-Frame Playback	42
3 Adjust the Volume	16	■ Slow Motion Playback	42
4 Tune in to a Station	16	■ Zoom	42
Other Basic Operations	17	MP3 Introduction	43
Enjoying Sounds from the External Component	17	MP3 Playback	44
Selecting an Appropriate Progressive Mode	17	Starting Playback	44
Turning Off the Power with the Timer	17	Operations Using the On-Screen Display	45
Speaker Settings	18	Moving to a Particular Track Directly	46
Setting the Delay Time	18	Repeating Playback	46
Creating Realistic Sound Fields	20	Tuner Operations	47
■ Dolby Digital and DTS Digital Surround	20	Tuning in Stations	47
■ Dolby Surround	20	Using Preset Tuning	48
■ DSP (Digital Signal Processor) Modes	21	Selecting the FM Reception Mode	48
Adjusting Stereo Sound	22	Setting up the DVD Preferences	49
Adjusting Dolby Digital and DTS Digital Surround	23	Setting the Initial Languages	49
Activating Dynamic Range Compression	24	Introducing the DVD Preference (System)	50
Adjusting Dolby Surround	24	Setting the Parental (Rating) Level	52
Adjusting DSP Modes	25	Operating JVC's Components	54
Disc Introduction—DVD/VCD/CD	27	Operating Other Manufacturers' TV	55
		Maintenance	56
		Troubleshooting	57
		Specifications	58

Center Unit



See pages in the parentheses for details.

Front Panel

- | | |
|-------------------------------------------------------------------------------------------------------------------------------------------------------------------------------------------------------------------------------------------------------------------------------------------------------------------------------------------------------------------------------------------------------------------------------------------------------------------------|----------------------------------------------------------------------------------------------------------------------------------------------------------------------------------------------------------------------------------------------------------------------------------------------------------------------------------------------------------------------------------------|
| <p>1 STANDBY/ON \odot/I button and STANDBY lamp (12 – 16)</p> <p>2 AUDIO/FM MODE button (30, 41, 48)</p> <p>3 Multi operation buttons
• \lll, \ggg, and \blacksquare</p> <p>4 Disc tray (12, 14)</p> <p>5 \blacktriangle (open/close) button (12 – 15, 35, 40, 44)
• Pressing this button also turns on the power and changes the source to the DVD player.</p> <p>6 Display window</p> | <p>7 Remote sensor</p> <p>8 $\blacktriangleright/\text{II}$ (play/pause) button (12, 13, 14, 15, 28, 44)
• Pressing this button also turns on the power and changes the source to the DVD player.</p> <p>9 DSP button (13, 15, 22, 25)</p> <p>10 VOLUME + and – buttons (12, 15, 16)</p> <p>11 SOURCE button (16, 17, 47, 48)</p> <p>12 Illumination lamp (12 – 16)</p> |
|-------------------------------------------------------------------------------------------------------------------------------------------------------------------------------------------------------------------------------------------------------------------------------------------------------------------------------------------------------------------------------------------------------------------------------------------------------------------------|----------------------------------------------------------------------------------------------------------------------------------------------------------------------------------------------------------------------------------------------------------------------------------------------------------------------------------------------------------------------------------------|

Display Window

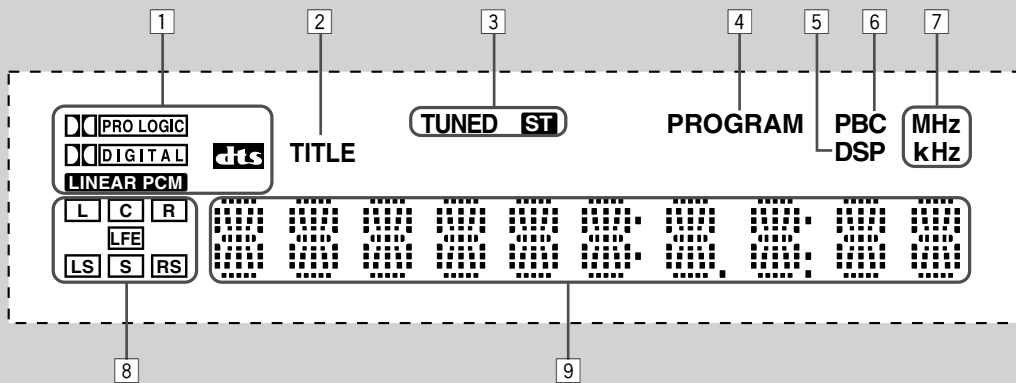

See pages in the parentheses for details.

Display Window

- | | |
|-----------------------------------------------------------------------------------------------------------------------------------------------------------------------------------------------------------------------------------------------------|--------------------------------------------------------------------------------------------------------------------------------------------------------------------------------------------------------------------------------------------------------------------------------------------|
| <p>1 Sound signal indicators (13, 15, 17, 20)
• PRO LOGIC, DOLBY DIGITAL, DTS, and LINEAR PCM</p> <p>2 TITLE indicator (28)</p> <p>3 Tuner mode indicators (16, 47, 48)
• TUNED and ST (stereo)</p> <p>4 PROGRAM indicator (34, 40, 48)</p> | <p>5 DSP indicator (21, 25)</p> <p>6 PBC (Play Back Control) indicator (37)</p> <p>7 Frequency unit indicators
• MHz (for FM station) and kHz (for AM station)</p> <p>8 Audio channel indicators
• Indicates audio channels currently being played back.</p> <p>9 Main display</p> |
|-----------------------------------------------------------------------------------------------------------------------------------------------------------------------------------------------------------------------------------------------------|--------------------------------------------------------------------------------------------------------------------------------------------------------------------------------------------------------------------------------------------------------------------------------------------|

Parts Identification

Remote Control

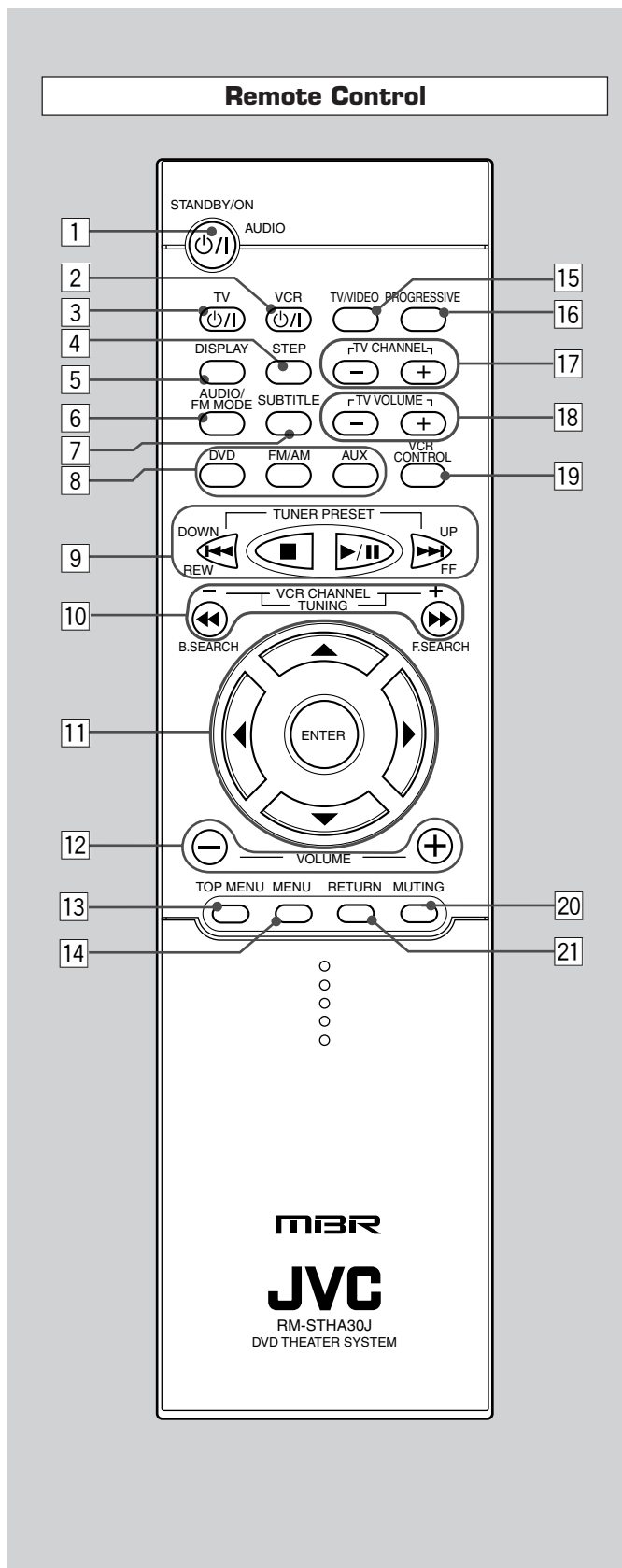

See pages in the parentheses for details.

Remote Control

- 1 STANDBY/ON \odot/I AUDIO button (12 – 16)
- 2 VCR \odot/I button (54)
- 3 TV \odot/I button (12, 14, 54, 55)
- 4 STEP button (36, 42, 54)
- 5 DISPLAY button (29, 37)
- 6 AUDIO/FM MODE button (30, 41, 48)
- 7 SUBTITLE button (30)
- 8 Source selecting buttons (12, 14, 16, 17, 24, 47)
 - DVD, FM/AM, AUX
 - Pressing one of these buttons also turns on the power.
- 9 \lll , \blacksquare , \ggg , and II buttons
 TUNER PRESET UP and DOWN buttons (48)
 FF (Fast-forward) and REW (Rewind) buttons
- 10 VCR CHANNEL + and – buttons (54)
 TUNING + and – buttons (16, 47)
 \ggg F. (Forward) SEARCH and \lll B. (Back) SEARCH buttons
- 11 Menu operation buttons
 - \blacktriangleright , \blacktriangleleft , \blacktriangleup , and \blacktriangledown buttons
 - ENTER button
- 12 VOLUME + and – buttons (12, 15, 16)
- 13 TOP MENU button (31)
- 14 MENU button (31, 38)
- 15 TV/VIDEO button (12, 14, 54, 55)
- 16 PROGRESSIVE button (11, 13, 17)
- 17 TV CHANNEL + and – buttons (54, 55)
- 18 TV VOLUME + and – buttons (54, 55)
- 19 VCR CONTROL button (54)

IMPORTANT:

If you press VCR CONTROL, this remote control will work ONLY for the JVC's VCR. When you want to operate the system again, press DVD or FM/AM.

- 20 MUTING button (12, 15)
- 21 RETURN button (38, 50, 51)

Inside the Cover

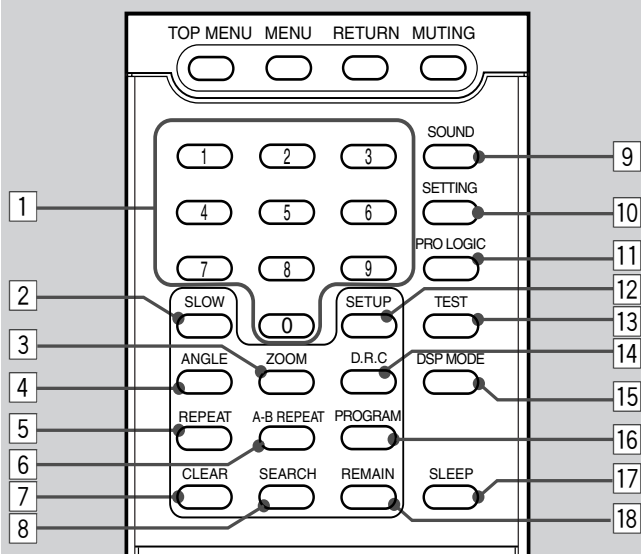

Inside the Cover

- 1 Number buttons (31, 38, 46, 54, 55)
- 2 SLOW button (36, 42)
- 3 ZOOM button (36, 42)
- 4 ANGLE button (30)
- 5 REPEAT button (33, 39, 46)
- 6 A-B REPEAT button (33, 39)
- 7 CLEAR button (32, 38, 41)
- 8 SEARCH button (32, 38, 46)
- 9 SOUND button (22 – 26)
- 10 SETTING button (18, 19)
- 11 PRO LOGIC button (17, 19, 22, 24)
- 12 SETUP button (50 – 53)
- 13 TEST button (21)
- 14 D.R.C button (24)
- 15 DSP MODE button (13, 15, 22, 25)
- 16 PROGRAM button (34, 35, 40, 48)
- 17 SLEEP button (17)
- 18 REMAIN button (31, 37)

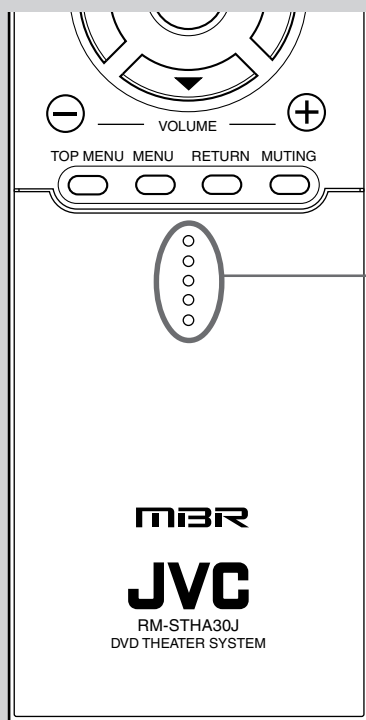

To open the cover of the remote control, push here then slide downward.

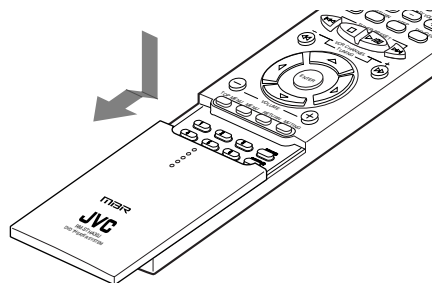

Before Installation

General Precautions

- DO NOT insert any metal object into the center unit.
- DO NOT disassemble the center unit or remove screws, covers, or cabinet.
- DO NOT expose the center unit to rain or moisture.

Locations

- Install the center unit in a location that is level and protected from moisture.
- The temperature around the center unit must be between 5°C and 35°C (41°F and 95°F).
- Make sure there is good ventilation around the center unit. Poor ventilation could cause overheating and damage the center unit.

Handling the center unit

- DO NOT touch the power cord with wet hands.
- DO NOT pull on the power cord to unplug the cord. When unplugging the cord, always grasp the plug so as not to damage the cord.
- Keep the power cord away from the connecting cords and the antenna. The power cord may cause noise or screen interference. It is recommended to use a coaxial cable for antenna connection, since it is well-shielded against interference.
- When a power failure occurs, or when you unplug the power cord, the preset settings such as preset FM/AM channels and sound adjustments may be erased in a few days.

Checking the Supplied Accessories

Check to be sure you have all of the following supplied accessories. The number in the parentheses indicates the quantity of the pieces supplied.

- Remote Control (1)
- Batteries (2)
- AM loop antenna (1)
- FM antenna (1)
- Video cord (1)

If anything is missing, contact your dealer immediately.

Putting Batteries in the Remote Control

Before using the remote control, put two supplied batteries first.

- When using the remote control, aim the remote control directly at the remote sensor on the center unit.

1. On the back of the remote control, remove the battery cover.

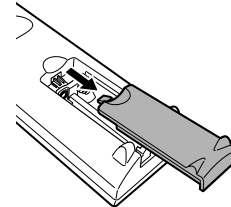

2. Insert batteries. Make sure to match the polarity: (+) to (+) and (-) to (-).

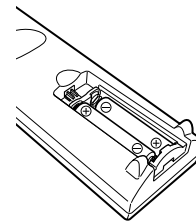

3. Replace the cover.

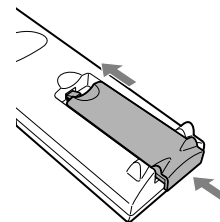

If the range or effectiveness of the remote control decreases, replace the batteries. Use two UM-4“AAA”/IEC “R03” type dry-cell batteries.

CAUTION:

Follow these precautions to avoid leaking or cracking cells:

- Place batteries in the remote control so they match the polarity: (+) to (+) and (-) to (-).
- Use the correct type of batteries. Batteries that look similar may differ in voltage.
- Always replace both batteries at the same time.
- Do not expose batteries to heat or flame.

Connecting the FM and AM Antennas

If AM reception is poor, connect single vinyl-covered wire (not supplied).

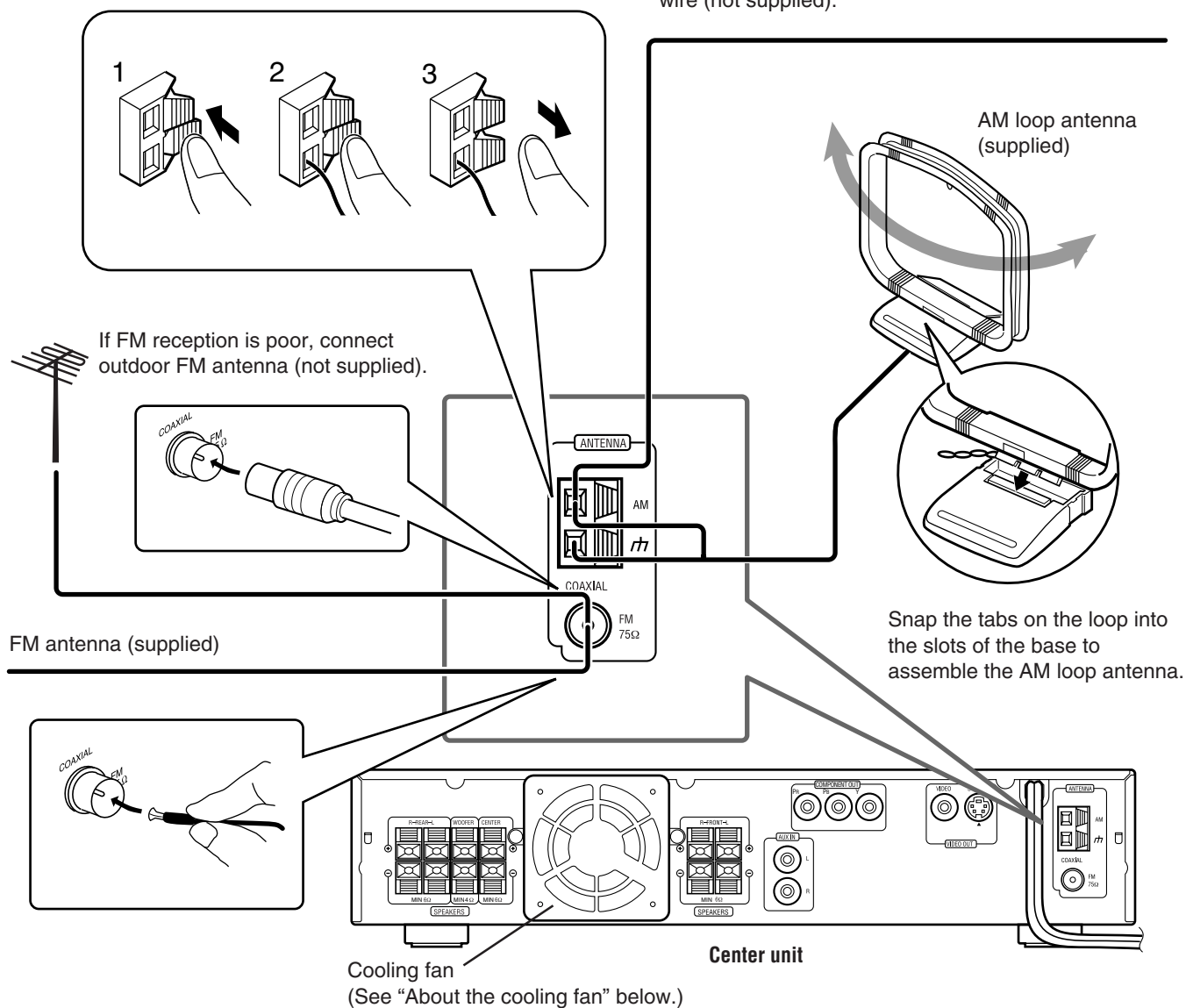

FM antenna connection

Connect the supplied FM antenna to the FM 75 Ω COAXIAL terminal as temporary measure.

Extend the supplied FM antenna horizontally.

- If reception is poor, connect an outdoor antenna. Before attaching a 75 Ω coaxial cable (with a standard type connector), disconnect the supplied FM antenna.

AM antenna connection

Connect the supplied AM loop antenna to the AM and r/r terminals. Turn the loop until you have the best reception.

- If reception is poor, connect an outdoor single vinyl-covered wire to the AM terminal. (Keep the AM loop antenna connected.)

Note:

If the AM loop antenna wire is covered with vinyl, remove the vinyl by twisting it as shown in the diagram.



About the cooling fan

A cooling fan is mounted on the rear panel of the center unit to prevent abnormal temperature inside the center unit, thus assuring normal operation of the unit. The cooling fan automatically starts rotating to supply external cool air to the inside of the center unit when the internal temperature goes up.

For safety, observe the following carefully.

- Make sure there is good ventilation around the center unit. Poor ventilation could overheat and damage the center unit.
- DO NOT block the cooling fan and the ventilation openings or holes. (If they are blocked by a newspaper or cloth, etc., the heat may not be able to get out.)
- DO NOT touch the speaker cords to the cooling fan.

Getting Started

Speaker Layout Diagram

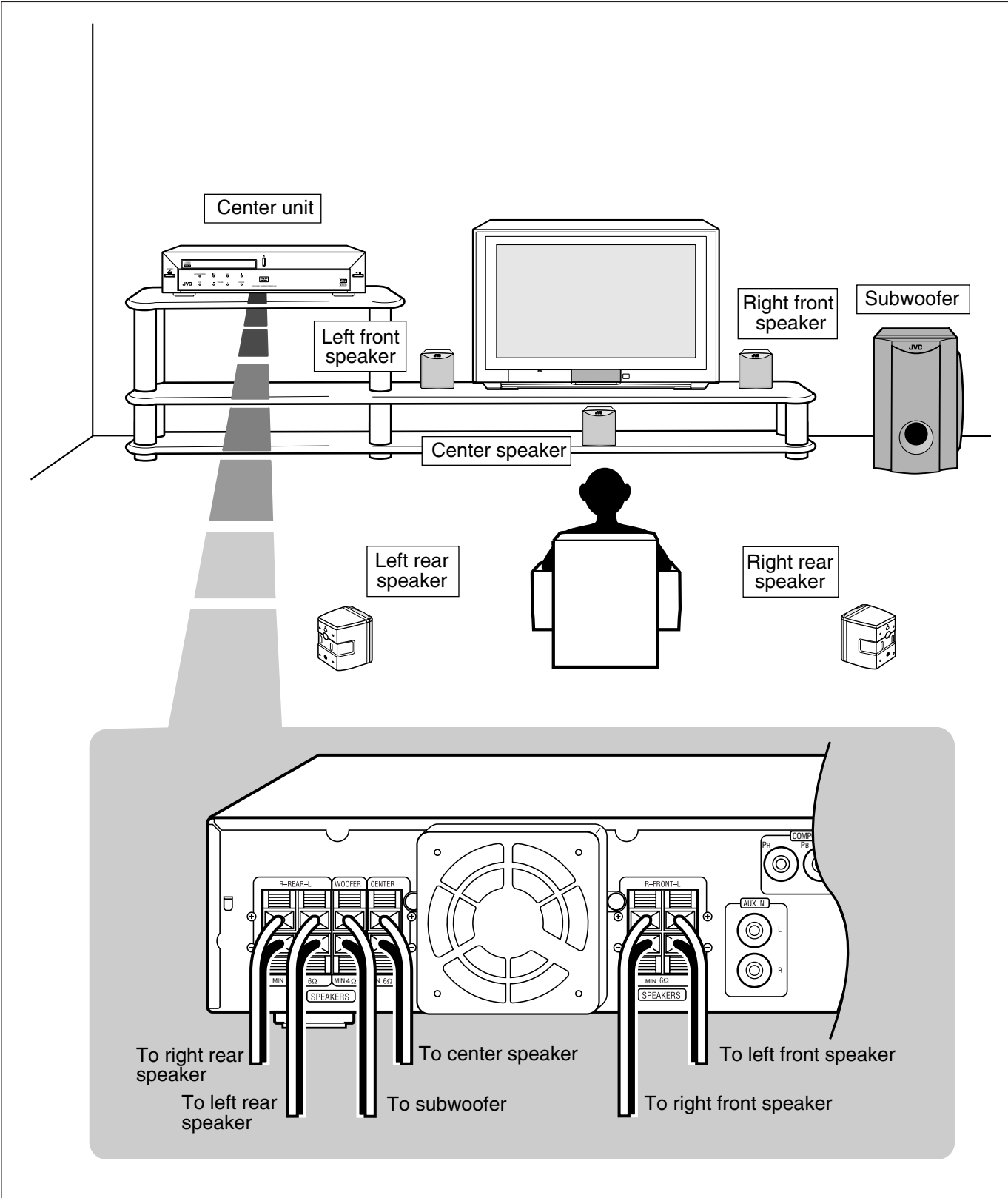

Connecting the Speakers

Connect the satellite speakers and subwoofer to the terminals on the rear panel using speaker cords supplied.

Labels are attached to the speaker cords to indicate the terminals to be connected.

- Connect the red cord to the red (+) terminal, and the black cord to the black (-) terminal respectively.

CAUTION:

Use speakers with the SPEAKER IMPEDANCE indicated by the speaker terminals.

Connecting speaker cords to the terminals

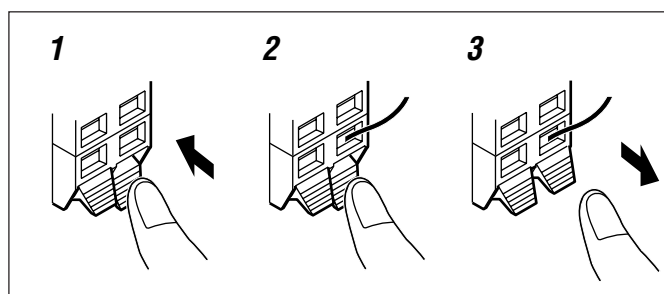

1 Press and hold the terminal clamp.

2 Insert the speaker cord.

3 Release the finger from the clamp.

Notes:

- If the speaker cord is covered with vinyl, remove the vinyl by twisting it as shown in the diagram.
- Make sure the core wire of speaker cords do not expose to out of the terminals. This could cause short-circuit.



When setting the speakers

To obtain the best possible sound from this system, you need to place all the speakers except the subwoofer at the same distance from the listening position with each front faced toward the listener. Since bass sound is non-directional, you can place a subwoofer wherever you like. Normally place it in front of you.

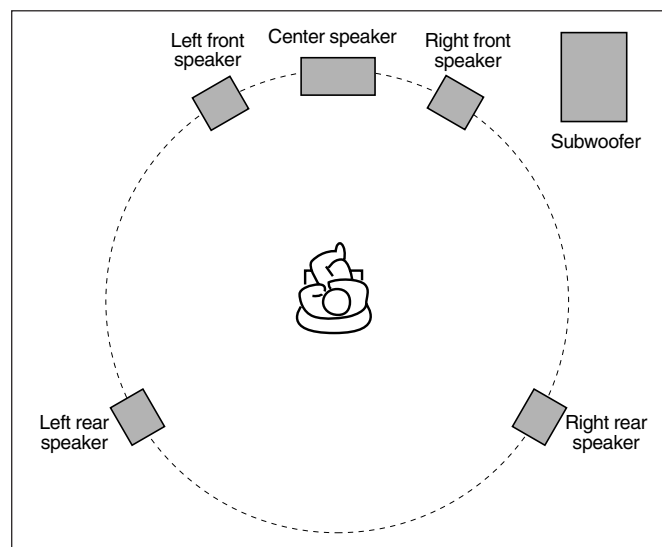

If your speakers cannot be placed at the same distance from the listening position

You can adjust the delay time of the center speaker and rear speakers. For in-depth information about adjusting the delay time, see "Setting the Delay Time" on page 18 and 19.

Note:

You can change the phase of subwoofer sounds by connecting the speaker cords to the terminals inversely—the red cord to the black terminal, and the black cord to the red terminal. You may get the more effective bass sounds by changing the phase.

CAUTION:

- When attaching the satellite speakers on the wall, have them attached to the wall by a qualified person.
DO NOT attach the satellite speakers on the wall by yourself to avoid an unexpected damage of their falling from the wall, caused by incorrect attachment or weakness in the wall.
- Care is required in selecting a location for attaching speakers to the wall. Injury to personnel, or damage to equipment, may result if the speakers are attached in a location which interferes with daily activities.

Getting Started

Connecting Audio/Video Component

Turn the power off to all components before connections.

Audio component connection

Connect another component to the center unit with the audio cords.

Use the cords supplied with another component or purchase them at an electric appliance store.

Audio cord (not supplied)

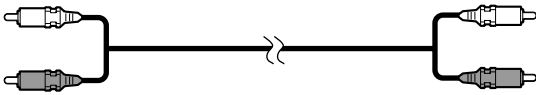

Illustrations of the input/output terminals below are typical examples.

When you connect another component, refer also to its manuals since the terminal name actually printed on the rear vary among the components.

If you connect a sound-enhancing device such as a graphic equalizer between the source component and the center unit, the sound output through this system may be distorted.

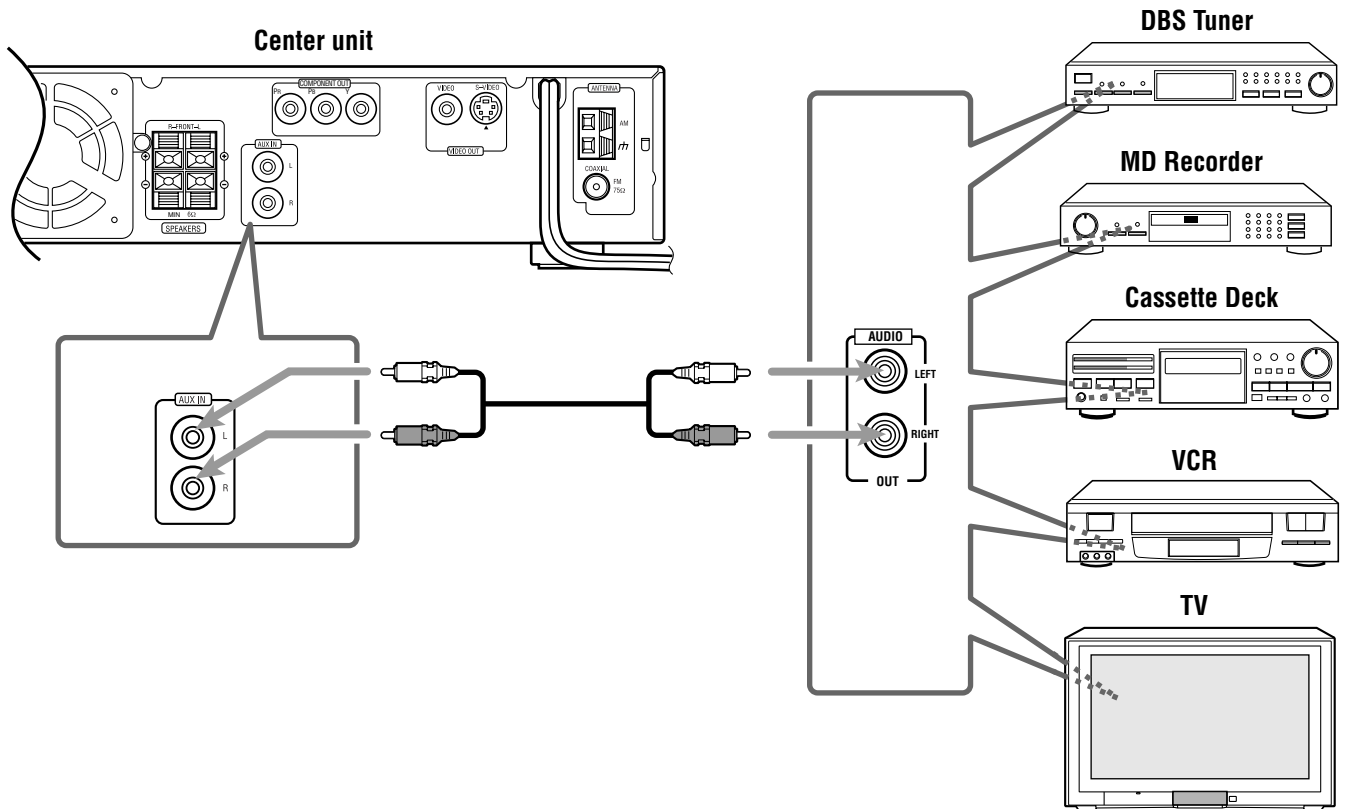

TV connection

The S-video cord and the component video cord are not supplied with this system.
Use the cords supplied with another components or purchase them at an electric appliance store.

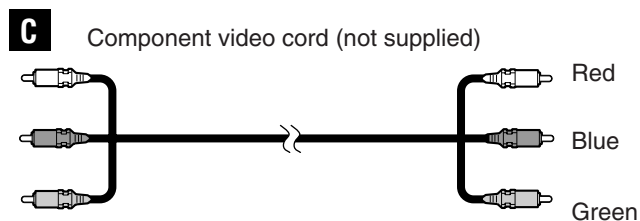
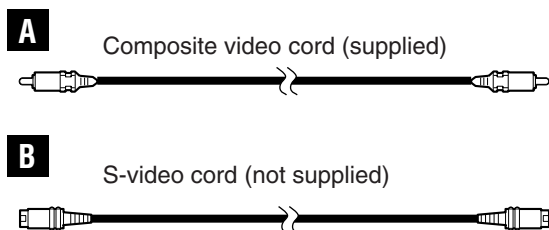

You can select one of three connection types—**A**, **B**, and **C**.

- If your TV has S-video (Y/C-separation) and/or component video (Y, Pr, Pb) jacks, connect them using an S-video cord (not supplied) **B** and/or component video cord (not supplied) **C**. By using these jacks, you can get a better picture quality—in the order : Component video > S-video > Composite video.
- If your TV supports the progressive video input, you can enjoy a high quality picture by making the progressive scan mode active.

Illustrations below are typical examples.

When you connect the TV, refer also to its manual since the terminal names actually printed on the rear vary among the components.

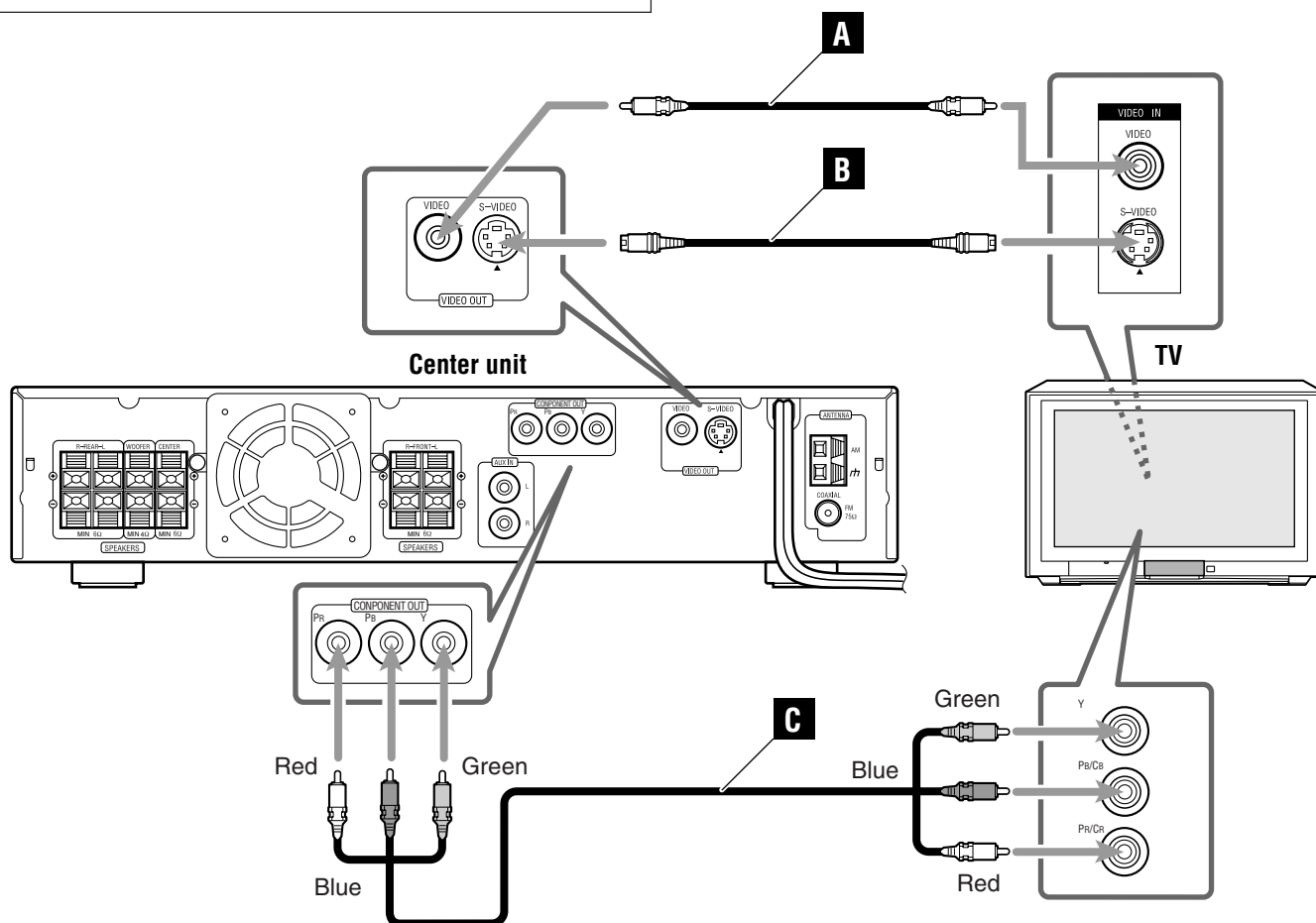

Now, you can plug the power cord of the center unit into the AC outlet.

Note:

Keep the power cord away from the connecting cords and the antenna cables. The power cord may cause noise or screen interference.

TV Preparation

This system supports the progressive scanning system (480p*) as well as the conventional interlaced scanning system (480i*).

If your TV equipped with component video jacks supports the progressive video input, you can enjoy a high quality picture by activating the progressive scanning mode.

- Refer also to the instruction manuals supplied with your TV.
- If your TV equipped with component video jacks does not support the progressive video input, do not change the scanning mode to the progressive scanning mode (P-SCAN MODE.)

* 480p and 480i indicate the number of scanning lines and scanning format of a video signal.

- 480p indicates 480 scanning lines with progressive format.
- 480i indicates 480 scanning lines with interlaced format.

About scanning system

The conventional scanning method to display video signals on the TV screen is called "Interlaced scanning." With this method, only half of the horizontal lines (called a "field") are displayed at a time. So two fields complete a single picture (frame); i.e., the first field, containing all the odd-numbered lines, is followed by the second field, containing all the even-numbered lines.

On the other hand, the Progressive scanning system scans all horizontal lines at a time, so you can double the number of scanning lines displayed at a time, resulting in a flicker-free, high-density picture.

To enjoy the progressive scanned picture, a monitor (or TV or projector) connected to the system must support the progressive video inputs.

Depending on the material source format, DVD video can be classified into two types; film source and video source (note that some DVD video contain both film source and video source). Film sources are recorded as 24-frame-per-second data, while (NTSC) video sources are recorded as 30-frame-per-second (60-field-per-second interlaced).

When this system plays back a film source data, uninterlaced progressive output signals are created using the original data. When a video source is played back, the unit interleaves lines between the interlaced lines to create the pseudo uninterlaced picture and outputs as the progressive signals.

Changing the Scan Mode

You can select the scanning mode if your TV equipped with component video jacks supports the progressive video input.

From the remote control ONLY:

1 Press DVD.

You can change the scan mode only when DVD is selected as the source and playback stops.

If a disc is no loaded, go to step 3.



2 Press ■.

Playback stops.



3 Press and hold PROGRESSIVE for a while.

- Each time you press and hold the button, the scan mode alternates between "I-SCAN MODE" and "P-SCAN MODE".



I (Interlace)-SCAN MODE

: Select this if your TV equipped with component video jacks does not support the progressive video input (conventional TV).

P (Progressive)-SCAN MODE

: Select this if your TV equipped with component video jacks supports the progressive video input.

Notes

- Some progressive TVs and High-Definition TVs are not fully compatible with this system, resulting in the unnatural picture when playing back a DVD in the progressive scanning mode. In such a case, change the scanning mode to "I-SCAN MODE" To check the compatibility of your TV, contact your local JVC customer service center.
- All JVC progressive TVs and High-Definition TVs are fully compatible with this system.

To select an appropriate progressive mode for playback pictures, see "Selecting an Appropriate Progressive Mode" on page 17.

Basic DVD Operations

This manual mainly explains operations using the buttons on the remote control. You can also use the buttons on the center unit if they have the similar names (or marks) as those on the remote control.

If operations using the center unit are different from those using the remote control, they are then explained.

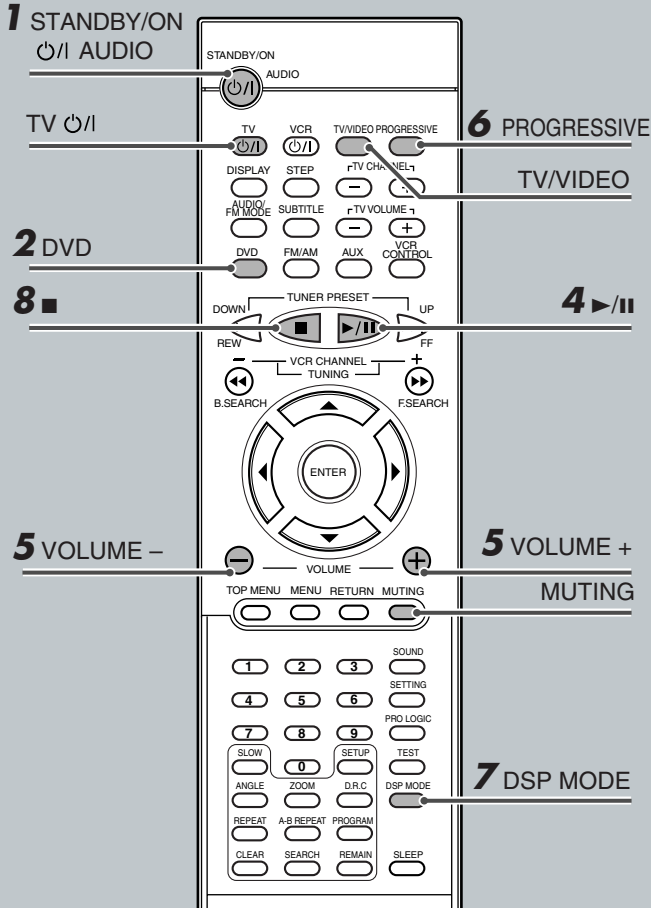

For in-depth information about DVD operations, see pages 27 to 36.

1 Turn On the Power

Before turning on the system, turn on your TV and select the correct video input. (See the manual supplied with your TV.)

- When you use a JVC's TV, you can turn on your TV by pressing TV on the remote control, and select the video input by pressing TV/VIDEO. (If your TV is not a JVC's, see "Operating Other Manufacturers' TV" on page 55.)
- For changing the OSD messages—the information on the TV screen—into the desired language, see "Setting the Initial Languages" on pages 49 and 50.

Press STANDBY/ON AUDIO (or STANDBY/ON on the front panel).

The STANDBY lamp goes off and the illumination lamp on the center unit lights up. The source indication selected previously appears on the display.



2 Select the Source

Press DVD.

The source changes to DVD.



3 Load a DVD

On the front panel ONLY:

Press to open the disc tray, then place a DVD correctly with its label side up.

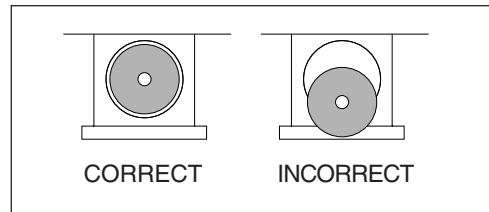

4 Start Playback

Press .

The disc tray closes. "LOADING" appears for a while.

- You can also start playback by closing the disc tray using on the front panel.

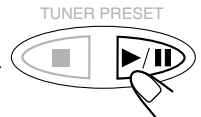

5 Adjust the Volume

To increase the volume, press and hold VOLUME +.

To decrease the volume, press and hold VOLUME -.



CAUTION:

Always set the volume to the minimum before starting any source. If the volume is set at its high level, the sudden blast of sound energy can permanently damage your hearing and/or ruin your speakers.

Notes:

- By pressing VOLUME + or - repeatedly, you can adjust the volume level step by step.
- The volume level can be adjusted within 51 steps—"MIN (minimum)," 01 to 49, and "MAX (maximum)."

To turn off the sounds temporarily

From the remote control ONLY:

Press MUTING.

To restore the sound, press MUTING again.

- Pressing VOLUME + or - also restores the sound.



Basic DVD Operations

6 Select an Appropriate Progressive Mode

You can select the progressive mode according to the picture type (film or video source).

Press **PROGRESSIVE** repeatedly until the progressive mode you want appears.

- Each time you press the button, the progressive mode changes as follows:

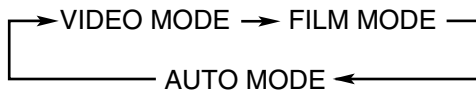

Notes:

- This mode is available only when progressive scanning mode is selected.
- For in-depth information about each progressive mode, see page 17.

7 Activate Surround or DSP Mode

You can enjoy two kinds of surround—Digital Multichannel Surround (Dolby Digital and DTS Digital Surround) and DSP modes.

Digital Multichannel Surround—Dolby Digital and DTS Digital Surround

Dolby Digital or DTS Digital Surround takes effect only when you enjoy a disc encoded with its signals—the DOLBY DIGITAL or DTS indicator lights up on the display.



Sound signal indicators on the display

To activate Dolby Digital or DTS Digital Surround

When a disc encoded with the Dolby Digital or DTS Digital Surround is loaded, the system detects it and starts playing the disc automatically with Multichannel Surround activated.

- For in-depth information about surround modes, see “Creating Realistic Sound Fields” on pages 20 and 25 .

DSP modes—THEATER, HALL, LIVE CLUB, DANCE CLUB

DSP modes take effect only when you enjoy a disc recorded using Linear PCM—the LINEAR PCM indicator lights up on the display.



Sound signal indicators on the display

To activate DSP modes

Press **DSP MODE** (or **DSP** on the front panel).

The DSP indicator lights up and the current DSP mode appears on the display for a while.

- Each time you press the button, DSP mode changes as follows:

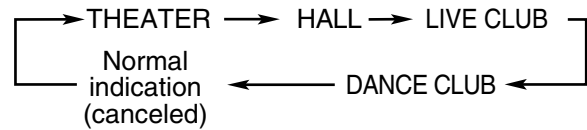

- For in-depth information about DSP modes, see “Creating Realistic Sound Fields” on pages 21, 25, and 26.

Note:

Before activating surround or DSP mode, adjust the speaker setting to bring out the best performance from this system.

For in-depth information about adjusting the speaker setting, see “Speaker Settings” on pages 18 and 19.

8 Stop Playback

Press **■** twice.

Playback stops completely and “DVD” appears on the display. (The DVD player goes on working for 3 minutes after playback stops.)

- This system can memorize the end point even when you press **■** once. When you start playback again by pressing **▶/II**, playback begins from where it has been stopped—Resume play.

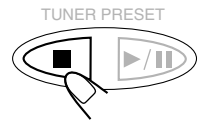

To remove the loaded disc

Press **▲**.

“OPEN” appears on the display and the disc tray comes out.

To close the disc tray, press **▲** again.

- If you do not press the button, the disc tray closes automatically after 3 minutes.



To turn off the power (into standby)

Press **STANDBY/ON** **⏻/I** **AUDIO** (or **STANDBY/ON** **⏻/I** on the front panel).

The illumination lamp goes off and the STANDBY lamp lights up.

- If you press **STANDBY/ON** **⏻/I** **AUDIO** (or **STANDBY/ON** **⏻/I** on the front panel) while the disc tray is kept open, the disc tray closes automatically, then the system is turned off.
- A small amount of power is consumed even in standby mode. To turn the power off completely, unplug the AC power cord.



Basic VCD/CD Operations

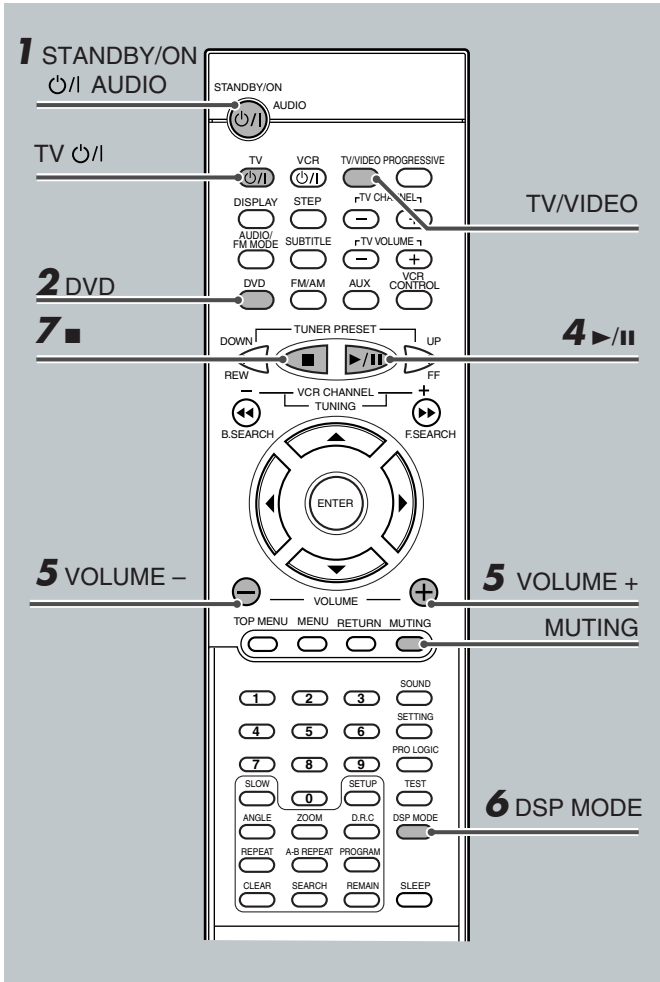

2 Select the Source

Press DVD.



3 Load a VCD/CD

On the front panel ONLY:

Press ▲ to open the disc tray, then place a disc correctly with its label side up.

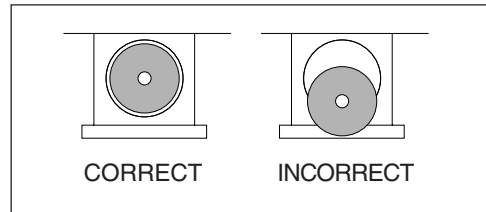

- When using a CD single (8 cm), place it on the inner circle of the disc tray.
- Continued use of irregular shape CDs (heart-shape, octagonal, etc.) can damage the center unit.

4 Start Playback

Press ►/||.

The disc tray closes. "LOADING" appears for a while.

- You can also start playback by closing the disc tray using ▲ on the front panel.



- SVCD can be operated by using the VCD operation procedure.
- For in-depth information about VCD/CD operations, see pages 27, 28, and 37 to 42.

1 Turn On the Power

Before turning on the system, turn on your TV if necessary and select the correct video input. (See the manual supplied with your TV.)

- When you use a JVC's TV, you can turn on your TV by pressing TV \odot/I on the remote control, and select the video input by pressing TV/VIDEO. (If your TV is not a JVC's, see "Operating Other Manufacturers' TV" on page 55.)
- For changing the OSD messages—the information on the TV screen—into the desired language, see "Setting the Initial Languages" on pages 49 and 50.

Press STANDBY/ON \odot/I AUDIO (or STANDBY/ON \odot/I on the front panel).

The STANDBY lamp goes off and the illumination lamp on the center unit lights up. The source indication selected previously appears on the display.



Basic VCD/CD Operations

5 Adjust the Volume

To increase the volume, press and hold VOLUME +.
To decrease the volume, press and hold VOLUME –.

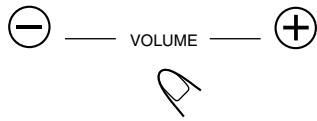

CAUTION:

Always set the volume to the minimum before starting any source. If the volume is set at its high level, the sudden blast of sound energy can permanently damage your hearing and/or ruin your speakers.

Notes:

- By pressing VOLUME + or – repeatedly, you can adjust the volume level step by step.
- The volume level can be adjusted within 51 steps—“MIN (minimum),” 01 to 49, and “MAX (maximum).”

To turn off the sounds temporarily

From the remote control ONLY:

Press MUTING.



To restore the sound, press MUTING again.

- Pressing VOLUME + or – also restores the sound.

6 Activate DSP Mode

You can enjoy DSP modes.

DSP modes—HALL, THEATER, LIVE CLUB, DANCE CLUB

DSP modes take effect only when you enjoy a disc recorded using Linear PCM—the LINEAR PCM indicator lights up on the display.

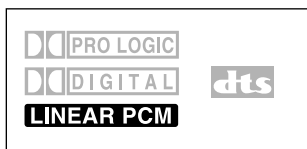

Sound signal indicators on the display

To activate DSP modes

Press DSP MODE (or DSP on the front panel).

The DSP indicator lights up and the current DSP mode appears on the display for a while.



- Each time you press the button, DSP mode changes as follows:

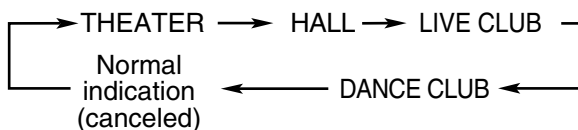

— For in-depth information about DSP modes, see “Creating Realistic Sound Fields” on pages 21, 25, and 26.

Note:

Before activating DSP mode, adjust the speaker setting to bring out the best performance from this system.
For in-depth information about adjusting the speaker setting, see “Speaker Settings” on pages 18 and 19.

7 Stop Playback

Press ■ twice.

Playback stops completely and “VCD” or “CD” appears on the display. (The DVD player goes on working for 3 minutes after playback stops.)



- This system can memorize the end point even when you press ■ once. When you start playback again by pressing ►/||, playback begins from where it has been stopped—Resume play.

To remove the loaded disc

Press ▲.

“OPEN” appears on the display and the disc tray comes out.



To close the disc tray, press ▲ again.

- If you do not press the button, the disc tray closes automatically after 3 minutes.

To turn off the power (into standby)

Press STANDBY/ON ⏻/|| AUDIO (or STANDBY/ON ⏻/|| on the front panel).

The illumination lamp goes off and the STANDBY lamp lights up.



- If you press STANDBY/ON ⏻/|| AUDIO (or STANDBY/ON ⏻/|| on the front panel) while the disc tray is kept open, the disc tray closes automatically, then the system is turned off.
- A small amount of power is consumed even in standby mode. To turn the power off completely, unplug the AC power cord.

Basic Tuner Operations

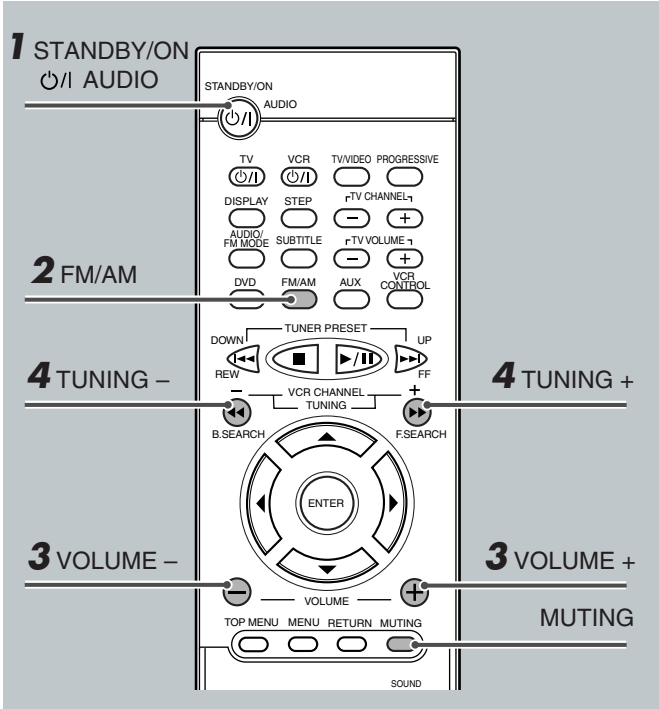

For in-depth information about tuner operations, see “Tuner Operations” on pages 47 and 48.

1 Turn On the Power

Press **STANDBY/ON** **AUDIO** (or **STANDBY/ON** on the front panel). The STANDBY lamp goes off and the illumination lamp lights up on the center unit. The source indication selected previously appears on the display.



2 Select the Band

From the remote control:

Press **FM/AM**.

The last received station of the selected band is tuned in.

- Each time you press the button, the band alternates between FM and AM.



On the front panel:

Press **SOURCE** repeatedly until the desired band (FM or AM) appears on the display.

- The last received station of the selected band is tuned in.
- Each time you press the button, the source changes as follows:

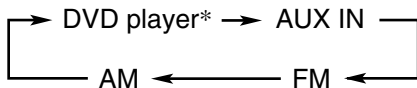

* “WAIT” appears on the display.

3 Adjust the Volume

To increase the volume, press and hold **VOLUME +**. To decrease the volume, press and hold **VOLUME -**.

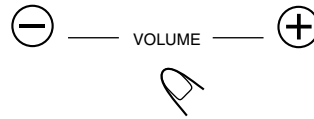

CAUTION:

Always set the volume to the minimum before starting any source. If the volume is set at its high level, the sudden blast of sound energy can permanently damage your hearing and/or ruin your speakers.

Notes:

- By pressing **VOLUME +** or **-** repeatedly, you can adjust the volume level step by step.
- The volume level can be adjusted within 51 steps—“MIN (minimum),” 01 to 49, and “MAX (maximum).”
- You can turn off the sounds temporarily by pressing **MUTING**.

4 Tune in to a Station

From the remote control:

Press and hold **TUNING +** or **-** until the station frequency starts changing continuously on the display. The system starts searching for a station.

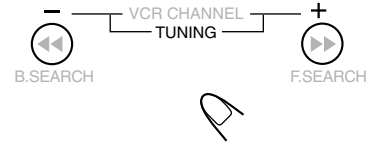

On the front panel:

- 1) Press so that “MANUAL” appears on the display.
- 2) Press and hold or until the station frequency starts changing continuously on the display. The system starts searching for a station.

Notes:

- When a station of sufficient signal strength is tuned in, the system stops searching, and the **TUNED** indicator lights up on the display.
- When an FM stereo program is received, the **ST** indicator also lights up.
- When you press the button repeatedly, the frequency changes step by step.

To turn off the power (into standby)

Press **STANDBY/ON** **AUDIO** (or **STANDBY/ON** on the front panel) again.

The illumination lamp goes off and the STANDBY lamp lights up.

- A small amount of power is consumed even in standby mode. To turn the power off completely, unplug the AC power cord.



Other Basic Operations

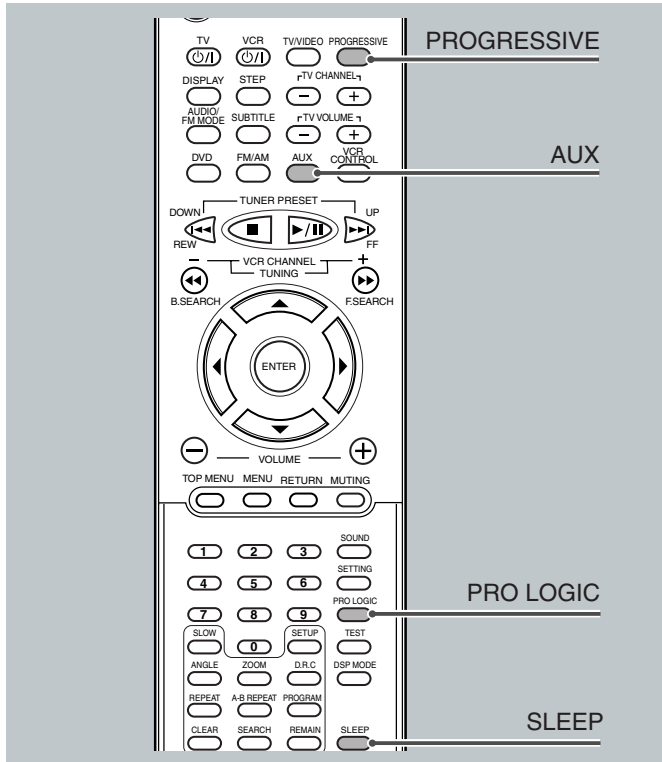

Enjoying Sounds from the External Component

You can enjoy sounds from the external component connected to the AUX IN jacks on the rear panel of the center unit.

1 Select AUX as the source.

From the remote control:

Press **AUX**.

Source changes to the external component connected to the AUX IN jacks.



On the front panel:

Press **SOURCE** repeatedly until "AUX IN" appears on the display.

- Each time you press the button, the source changes as follows:

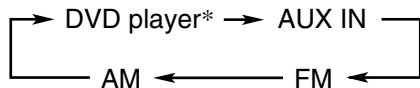

* "WAIT" appears on the display.

2 Start playback on the external component.

- For in-depth information about the external equipment, see the manual supplied for it.

When you listen to analog sounds encoded with Dolby Surround, you can enjoy Dolby Surround.

3 Press PRO LOGIC to activate Dolby Surround.

- Each time you press the button, Dolby Surround mode changes as follows:

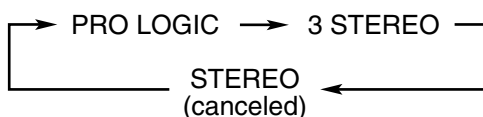

- When Dolby Surround activates, the PRO LOGIC indicator lights up on the display.

- For in-depth information about Pro Logic modes, see "Creating Realistic Sound Fields" on pages 20 and 24.

Selecting an Appropriate Progressive Mode

You can select an appropriate progressive mode according to the picture type (film or video source).

From the remote control ONLY:

Press **PROGRESSIVE** repeatedly during playback until the progressive mode you want appears.



- Each time you press the button, the progressive mode changes as follows:

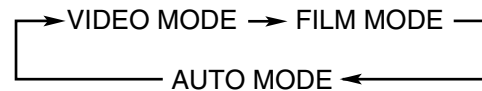

VIDEO MODE : Suitable for playing back a video source disc.

FILM MODE : Suitable for playing back a film or progressive source disc.

AUTO MODE : Normally select this. Used to play a disc containing both video and film source materials.

This system recognizes the picture type (film or video source) of the current chapter.

- If the playback picture is unclear or noisy, or the oblique lines of the picture are rough, try to change to other modes.

Notes:

- This mode is available only when progressive scanning mode is selected (see page 11).
- For VCD/SVCD playback, VIDEO MODE is selected automatically and cannot be changed.

Turning Off the Power with the Timer

You can fall asleep while listening to music—Sleep Timer.

From the remote control ONLY:

Press **SLEEP**.

- Each time you press the button, the shut-off time changes as follows:

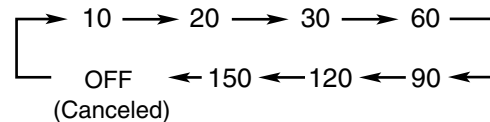

When the shut-off time comes, the system turns off automatically.

To check or change the time remaining until the shut-off time

Press **SLEEP** once.

The remaining time (in minutes) appears on the display.

- By pressing SLEEP, you can change the shut-off time.



To cancel the Sleep Timer

Press **SLEEP** repeatedly until "OFF" appears on the display.

- Turning off the power also cancels the Sleep Timer.



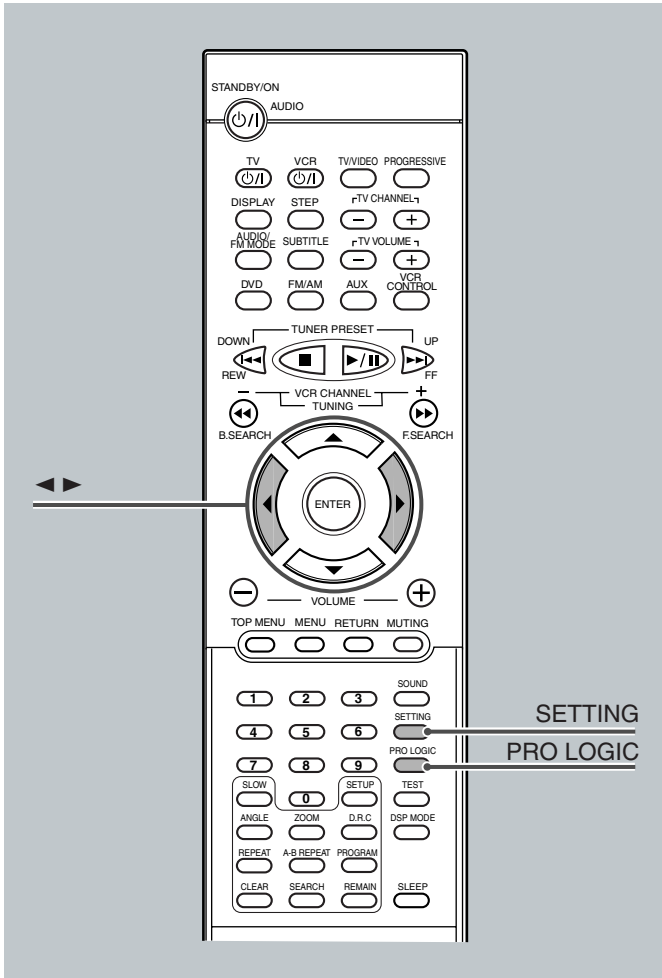

Setting the Delay Time

Adjust the delay time of the sounds from the center speaker and the rear speakers, comparing to that of the sounds from the front speakers. If the distance to the center speaker* and/or the rear speakers** from your listening point is almost the same as from the front speakers, select "00 MS (msec)."

- * You can adjust the delay time only when the DOLBY DIGITAL or DTS indicator is lit on the display.
- ** You can adjust the delay time only when the DOLBY DIGITAL, DTS, or PRO LOGIC indicator is lit on the display.

For Dolby Digital or DTS Digital Surround:

Before you start, remember...

There is a time limit in doing the following steps. If the setting is canceled before you finish, start from step 1 again.

- 1 Select and play a DVD encoded with Dolby Digital or DTS Digital Surround.
- 2 Press **SETTING** repeatedly until one of delay time indications (with the current setting*) appears on the display.

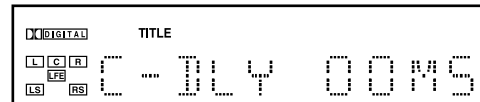

- Each time you press the button, the indication in the main display changes as follows:

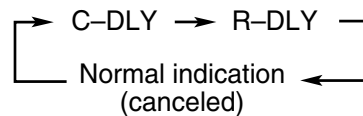

C-DLY (Center delay) : To register delay time for center speaker—from 0 msec to 5 msec

R-DLY (Rear delay) : To register delay time for rear speakers—from 0 msec to 15 msec

- * The initial setting for the center speaker is "00 MS." The initial setting for the rear speakers is "00 MS." If you have already changed the setting, a different value will be shown.

3 Press ► or ◀ to adjust delay time.

- ► : Increases delay time.
- ◀ : Decreases delay time.
- 1 msec increase (or decrease) in delay time corresponds to 30 cm increase (or decrease) in distance.

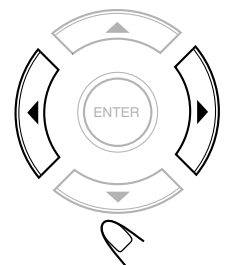

4 Repeat steps 2 and 3 to adjust the other delay time.

Speaker Settings

For Dolby Pro Logic:

Before you start, remember...

There is a time limit in doing the following steps. If the setting is canceled before you finish, start from step 1 again.

- 1** Press **AUX** to select the external component as the source.



- 2** Start playing a source encoded with Dolby Surround.

- 3** Press **PRO LOGIC** repeatedly on the remote control to select Dolby Pro Logic.



- 4** Press **SETTING** repeatedly until one of delay time indications (with the current setting*) appears on the display.

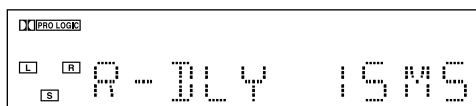

- Each time you press the button, the indication in the main display changes as follows:

R-DLY ↔ Normal indication (canceled)

R-DLY (Rear delay) : To register delay time for rear speakers—from 15 msec to 30 msec.

* The initial setting for the rear speakers is "15 MS."
If you have already changed the setting, a different value will be shown.

- 5** Press **▶** or **◀** to adjust delay time.

- ▶ : Increases delay time.
- ◀ : Decreases delay time.
- 1 msec increase (or decrease) in delay time corresponds to 30 cm increase (or decrease) in distance.

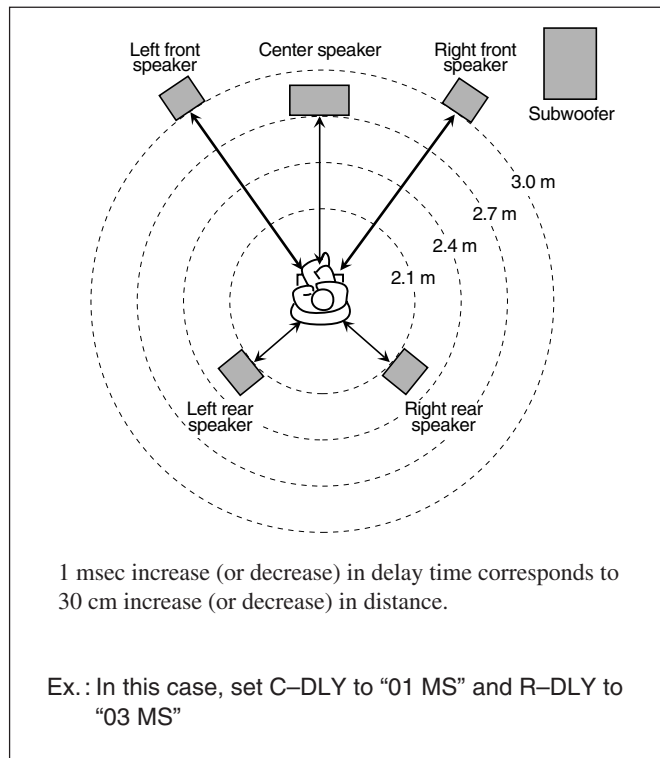
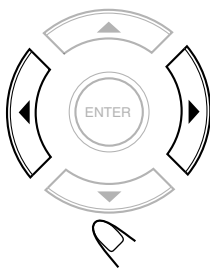

Creating Realistic Sound Fields

You can use the following surround to reproduce a realistic sound field.

- Digital Multichannel Surround—Dolby Digital and DTS Digital Surround
- Dolby Surround
- DSP (Digital Signal Processor) modes

■ Dolby Digital and DTS Digital Surround

To enjoy surround effectively, all the speakers need to be connected and activated.

Dolby Digital*

Used to reproduce multichannel sound tracks of the software encoded with Dolby Digital ().

Dolby Digital encoding method (so-called discrete 5.1 channel digital audio format) records and digitally compresses the left front channel, right front channel, center channel, left rear channel, right rear channel, and LFE channel signals (total 6 channels, but LFE channel is counted as 0.1 channel. Therefore, called 5.1 channel). Since each channel is completely independent from the other channel signals to avoid interference, you can obtain much better sound quality with much stereo and surround effects.

In addition, Dolby Digital enables stereo rear sounds, and sets the cutoff frequency of the rear treble at 20 kHz, compared to 7 kHz for Dolby Pro Logic. These facts enhance the sound movement and being-there feelings much more than Dolby Pro Logic.

When the system detects Dolby Digital signals, the DOLBY DIGITAL indicator lights up on the display.

DTS Digital Surround**

Used to reproduce multichannel sound tracks of the software encoded with DTS Digital Surround ().

DTS Digital Surround is another discrete 5.1 channel digital audio format available on CD, LD, and DVD software.

Compared to Dolby Digital, audio compression rate is relatively low. This fact allows DTS Digital Surround format to add breadth and depth to the reproduced sounds. As a result, DTS Digital Surround features natural, solid and clear sound.

When the system detects DTS Digital Surround signals, the DTS indicator lights up on the display.

■ Dolby Surround*

Used to reproduce sound tracks of the VCR tapes encoded with Dolby Surround ().

This is only used for the sound sources coming through the AUX IN jacks.

Dolby Pro Logic and Dolby 3 Stereo

Dolby Surround encoding format records the left front channel, right front channel, center channel, and rear channel signals (total 4 channels) into 2 channels.

The **Dolby Pro Logic** decoder built in this system decodes these 2 channel signals into original 4 channel signals—matrix-based multichannel reproduction, and allows you to enjoy a realistic stereo sound in your listening room.

When one of Dolby Surround is selected, the PRO LOGIC indicator lights up on the display.

Indications on the display for each surround

• Dolby Digital

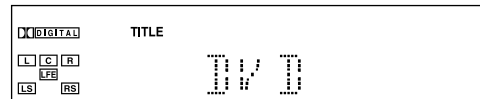

• DTS Digital Surround

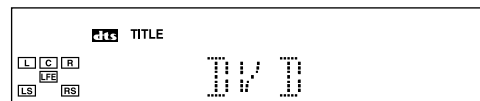

• Dolby Pro Logic

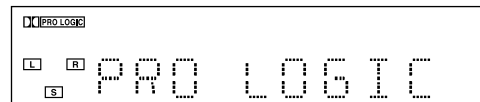

• Dolby 3 Stereo

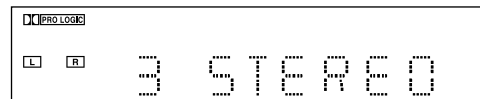

• DSP*

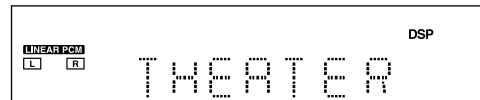

* When you select FM/AM or AUX as the source, the Linear PCM indicator () does not light up.

— According to the speaker settings, some speaker indicators do not light up. In this case, set the speaker setting appropriately (see page 18.)

* Manufactured under license from Dolby Laboratories. "Dolby," "Pro Logic," and the double-D symbol are trademarks of Dolby Laboratories. Confidential Unpublished Works. ©1992–1997 Dolby Laboratories. All rights reserved.

** Manufactured under license from Digital Theater Systems, Inc. US Pat. No. 5,451,942 and other world-wide patents issued and pending. "DTS" and "DTS Digital Surround" are trademarks of Digital Theater Systems, Inc. ©1996 Digital Theater Systems, Inc. All rights reserved.

Creating Realistic Sound Fields

■ DSP (Digital Signal Processor) Modes

DSP modes have been designed to create important acoustic surround elements.

The sound heard in a hall, a theater, a pavilion, a dance club, or a live club consists of direct sound and indirect sound—early reflections and reflections from behind. Direct sounds reach the listener directly without any reflection. On the other hand, indirect sounds are delayed by the distances of the ceiling and walls. These indirect sounds are important elements of the acoustic surround effects.

The following DSP modes are provided with this unit.

THEATER	: Gives the feeling of a theater.
HALL	: Gives clear vocal and the feeling of a concert hall.
LIVE CLUB	: Gives the feeling of a live music club with a low ceiling.
DANCE CLUB	: Gives a throbbing bass beat.

These DSP modes can be used to add the acoustic surround effects while reproducing stereo analog software or Linear PCM digital software, and can give you a real “being there” feeling.

When one of the DSP modes is selected, the DSP indicator lights up on the display.

To check the speaker connections and settings using the test tone

1. Select and play a DVD encoded with Dolby Digital or DTS Digital Surround.
2. Press TEST on the remote control.
The test tone comes out from the speakers (except the subwoofer) in the order.
 - If there is a speaker from which no sounds comes out, check the speaker's connection (see pages 7 and 8).
3. Press TEST again to stop the test tone.



Available surround according to the input signal format

○: Possible ×: Impossible

Surround	Multichannel Surround	Pro Logic*		DSP				(canceled)
		Pro Logic	3 Stereo	THEATER	HALL	LIVE CLUB	DANCE CLUB	STEREO
Input Signal format	Analog	×	○	○	○	○	○	○
	Linear PCM	×	○	○	○	○	○	○
	Dolby Digital Multichannel	○	×	×	×	×	×	×
	Dolby Surround	×	○	○	○	○	○	○
	DTS Digital Surround	○	×	×	×	×	×	×

* You can use Pro Logic mode for all 2 channel sources, but surround effect does not work sufficiently except Dolby Surround encoded source.

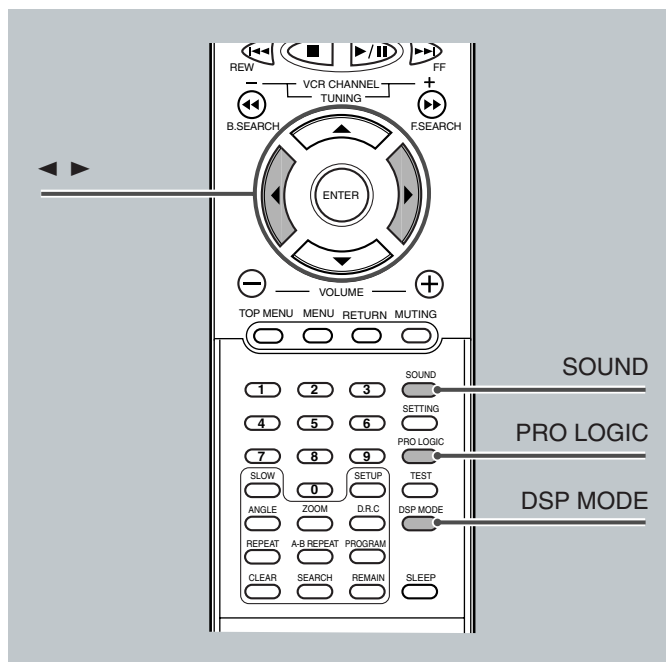

Adjusting Stereo Sound

You can adjust the following settings.

It is recommended that you make adjustments from your actual listening point while listening to reproduced sounds.

- Output balance for the front speakers
- Output level for the subwoofer

Once you adjust these items, the adjustments take effect for all the surround modes.

Before you start, remember...

- There is a time limit in doing the following steps. If the setting is canceled before you finish, start from step **2** again.

1 Select and play any source except Dolby Digital or DTS Digital Surround.

2 Cancel Dolby Surround or DSP modes if they are activated.

For deactivating Dolby Surround:

Press **PRO LOGIC** on the remote control until “STEREO” appears on the display.



For deactivating DSP modes:

Press **DSP MODE** (or **DSP** on the front panel) until the DSP indicator goes off from the display.



Now, you are ready to start adjustments.

- To adjust the output balance for the front speakers, go to the next step.
- To adjust the output level for the subwoofer, go to step **4**.

3 To adjust the output balance for the front speakers

1) Press **SOUND** repeatedly until the adjustment indication for the front speakers appears on the display.



- Each time you press the button, the adjustment indication on the display changes as follows:

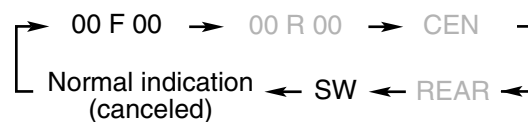

2) Press **▶** or **◀** to adjust the output balance.

- ▶ : Decreases the left speaker output, or restores the right speaker output.
- ◀ : Decreases the right speaker output, or restores the left speaker output.

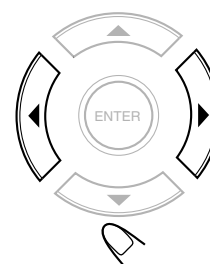

- The output balance changes from OFF (silence), –06 (most reduction) to 00 (no reduction).
- “00 F 00” is the initial setting (the output balance is at the center position). If you have already changed the setting, another value will appear.

4 To adjust the output level for the subwoofer

1) Press **SOUND** repeatedly to select “SW.”



- Each time you press the button, the adjustment indication on the display changes as follows:

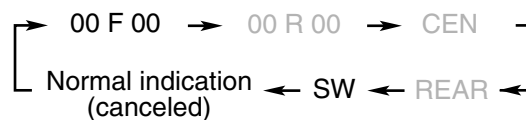

2) Press **▶** or **◀** to adjust the output level.

- ▶ : Increases the output level.
- ◀ : Decreases the output level.
- To adjust the output level for subwoofer (from –6 dB to +6 dB).
- “SW 0dB” is the initial setting. If you have already changed the settings, another value will appear.

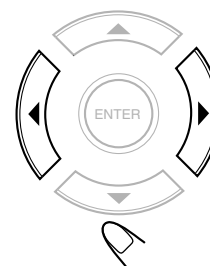

Creating Realistic Sound Fields

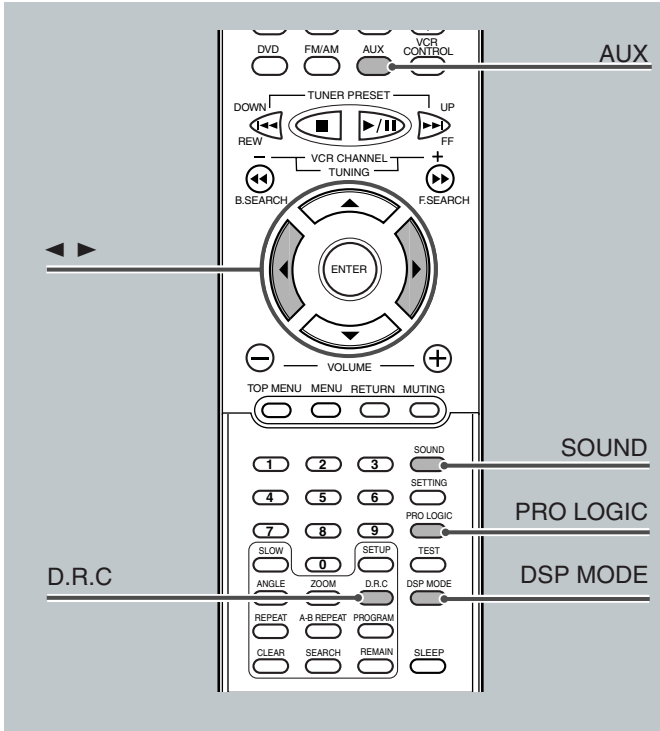

Adjusting Dolby Digital and DTS Digital Surround

You can adjust the following settings while activating Dolby Digital or DTS Digital Surround.

It is recommended that you make adjustments from your actual listening point while listening to reproduced sounds.

- Output balance for the front speakers
- Output balance for the rear speakers
- Output level for the center speaker
- Output level for the rear speakers*
- Output level for the subwoofer

* The adjustment is separately memorized for Digital Multichannel Surround (Dolby Digital and DTS Digital Surround), and for Dolby Pro Logic.

Before you start, remember...

- There is a time limit in doing the following steps. If the setting is canceled before you finish, start from step **2** again.

1 Select and play a DVD encoded with Dolby Digital or DTS Digital Surround.

Now, you are ready to start adjustments.

- To adjust the output balance for the front speakers and the rear speakers, go to the next step.
- To adjust the output level for the center speaker, the rear speakers, and the subwoofer, go to step **3**.

2 To adjust the output balance for the front speakers and the rear speakers

- 1) Press **SOUND** repeatedly until one of the following adjustment indications appears on the display.



- Each time you press the button, the adjustment indication on the display changes as follows:

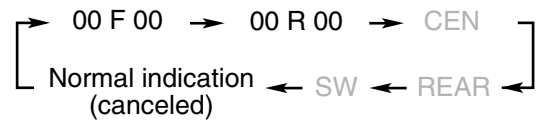

00 F (Front) 00 : To adjust the output balance for the front speakers.

00 R (Rear) 00 : To adjust the output balance for the rear speakers.

- “00 F 00” and “00 R 00” are the initial setting (the output balances are at the center position). If you have already changed the setting, another value will appear.

2) Press **▶** or **◀** to adjust the output balance.

- ▶ : Decreases the left speaker output, or restores the right speaker output.
- ◀ : Decreases the right speaker output, or restores the left speaker output.

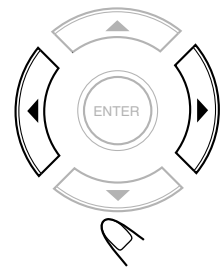

- Each output balance changes from OFF (silence), -06 (most reduction) to 00 (no reduction).

3) Repeat 1) and 2) for setting the other speaker.

3 To adjust the output levels for the center speaker, the rear speakers, and the subwoofer

1) Press **SOUND** repeatedly to select the “CEN,” “REAR,” or “SW.”

- Each time you press the button, the adjustment indication on the display changes as follows:

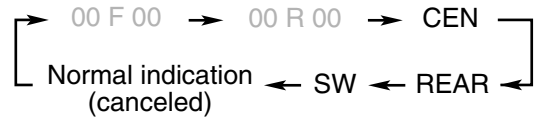

CEN (Center) : To adjust the output level for center speaker (from -6 dB to +6 dB).

REAR : To adjust the output level for rear speakers (from -6 dB to +6 dB).

SW (Subwoofer) : To adjust the output level for subwoofer (from -6 dB to +6 dB).

- “CEN 0dB,” “REAR 0dB,” and “SW 0dB” are the initial settings. If you have already changed the settings, another value will appear.

2) Press **▶** or **◀** to adjust the output level.

- ▶ : Increases the output level.
- ◀ : Decreases the output level.

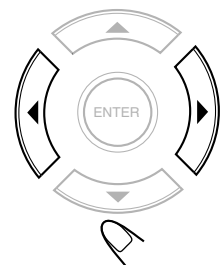

3) Repeat 1) and 2) for setting the other speakers.

Activating Dynamic Range Compression

You can enjoy a powerful sound even at a low volume level by compressing the dynamic range (difference between the maximum and minimum sounds).

- This function takes effect only when Dolby Digital is activated.

From the remote control ONLY:

Press D.R.C.

- Each time you press the button, the dynamic range compression mode alternates between on and off. Select "DRC ON" while watching the DVD at night. (You can obtain a powerful sound at a low volume.)



Adjusting Dolby Surround

You can adjust the following settings while activating Dolby Surround.

It is recommended that you make adjustments from your actual listening point while listening to reproduced sounds.

- Output balance for the front speakers
- Output balance for the rear speakers
- Output level for the rear speakers*
- Output level for the subwoofer
- When Dolby 3 Stereo is activated, you cannot adjust the rear speakers.
- * The adjustment is separately memorized for Digital Multichannel Surround (Dolby Digital and DTS Digital Surround), and for Dolby Pro Logic.
- Dolby Surround cannot be used with DSP modes. Once one of Dolby Surround is activated, DSP modes in use will be canceled.

Before you start, remember...

- There is a time limit in doing the following steps. If the setting is canceled before you finish, start from step **3** again.

1 Press AUX to select the external component as the source.



2 Start playing a source encoded with Dolby Surround.

3 Press PRO LOGIC repeatedly on the remote control to select Dolby Pro Logic or Dolby 3 Stereo.



The PRO LOGIC indicator lights up on the display.

- Each time you press the button, the indication changes as follows:

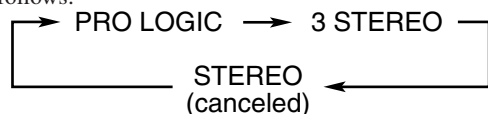

Now, you are ready to start adjustments.

- To adjust the output balance for the front speakers and the rear speakers, go to the next step.
- To adjust the output level for the center speaker, the rear speakers, and the subwoofer, go to step **5** on the next page.

4 To adjust the output balance for the front speakers and the rear speakers

1) Press SOUND repeatedly until one of the following adjustment indications appears on the display.



- Each time you press the button, the adjustment indication on the display changes as follows:

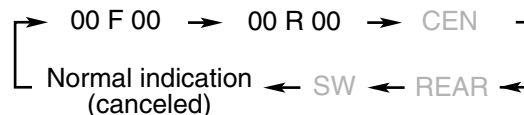

00 F (Front) 00 : To adjust the output balance for the front speakers.

00 R (Rear) 00 : To adjust the output balance for the rear speakers.

- When selecting "3 STEREO," you cannot adjust the output balance for the rear speakers.
- "00 F 00" and "00 R 00" are the initial settings (the output balances are at the center position). If you have already changed the setting, another value will appear.

2) Press ► or ◀ to adjust the output balance.

- : Decreases the left speaker output, or restores the right speaker output.
- ◀ : Decreases the right speaker output, or restores the left speaker output.
- Each output balance changes from OFF (silence), -06 (most reduction) to 00 (no reduction).

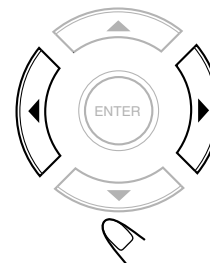

3) Repeat 1) and 2) for setting the other speakers.

Creating Realistic Sound Fields

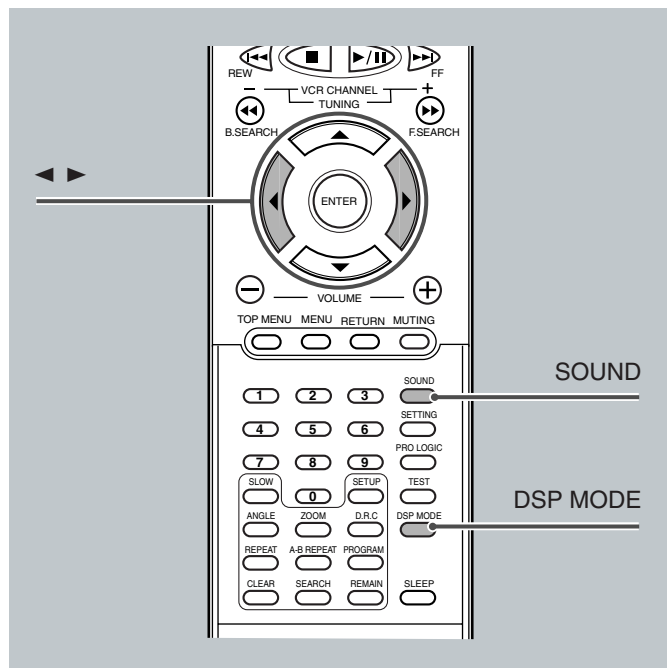

5 To adjust the output level for the center speaker, the rear speakers, and the subwoofer

1) Press SOUND repeatedly to select the “CEN,” “REAR,” or “SW.”

- Each time you press the button, the adjustment indication on the display changes as follows:

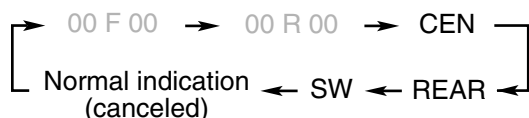

CEN (Center) : To adjust the output level for center speaker (from -6 dB to +6 dB).

REAR : To adjust the output level for rear speakers (from -6 dB to +6 dB).

SW (Subwoofer) : To adjust the output level for subwoofer (from -6 dB to +6 dB).

- When selecting “3 STEREO,” you cannot adjust the output levels for the rear speakers.
- “CEN 0dB,” “REAR 0dB,” and “SW 0dB” are the initial settings. If you have already changed the settings, another value will appear.

2) Press ► or ◀ to adjust the output level.

- : Increases the output level.
- ◀ : Decreases the output level.

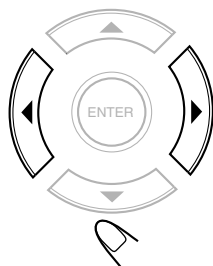

3) Repeat 1) and 2) for setting the other speakers.

Adjusting DSP Modes

You can adjust the following settings while activating DSP modes. It is recommended that you make adjustments from your actual listening point while listening to reproduced sounds.

- Output balance for the front speakers
- Output balance for the rear speakers
- Output level for the rear speakers
- Output level for the subwoofer

- DSP modes cannot be used with Dolby Surround. Once one of DSP modes is activated, Dolby Surround in use will be canceled.
- When you play back a DVD encoded with Dolby Digital or DTS Digital Surround, DSP MODE button (or DSP button on the center unit) does not work.

Before you start, remember...

- There is a time limit in doing the following steps. If the setting is canceled before you finish, start from step 2 again.

1 Select and play any source except Dolby Digital or DTS Digital Surround.

2 Press DSP MODE (or DSP on the front panel) repeatedly to select the desired DSP mode.



The DSP indicator lights up on the display while the DSP modes are activated.

- Each time you press the button, DSP mode changes as follows:

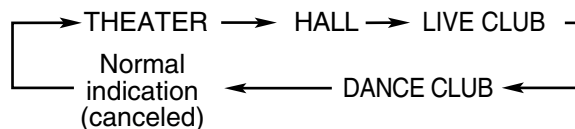

Now, you are ready to start the adjustment.

- To adjust the output balance for the front speakers and the rear speakers, go to the next step.
- To adjust the output level for the rear speakers, go to step 4 on the next page.

3 To adjust the output balance for the front speakers and the rear speakers

1) Press SOUND repeatedly until one of the following adjustment indications appears on the display.

- Each time you press the button, the adjustment indication on the display changes as follows:

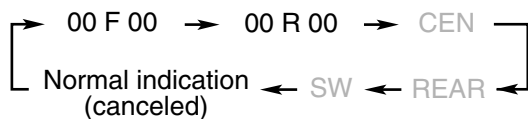

00 F (Front) 00 : To adjust the output balance for the front speakers.

00 R (Rear) 00 : To adjust the output balance for the rear speakers.

- “00 F 00” and “00 R 00” are the initial setting (the output balances are at the center position). If you have already changed the setting, another value will appear.

2) Press ► or ◀ to adjust the output balance.

- : Decreases the left speaker output, or restores the right speaker output.

- ◀ : Decreases the right speaker output, or restores the left speaker output.

- Each output balance changes from OFF (silence), -06 (most reduction) to 00 (no reduction).

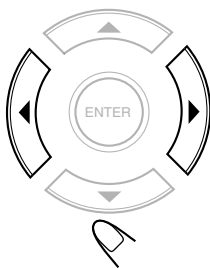

4 To adjust the output level for the rear speakers

1) Press SOUND repeatedly until “REAR” appears on the display.

- Each time you press the button, the adjustment indication on the display changes as follows:

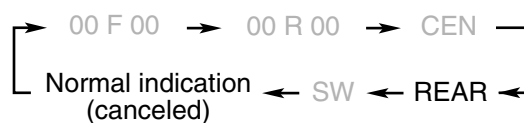

REAR : To adjust the output level for rear speakers (from -6 dB to +6 dB).

- “REAR 0dB” is the initial setting. If you have already changed the setting, another value will appear.

2) Press ► or ◀ to adjust the output level.

- : Increases the output level.

- ◀ : Decreases the output level.

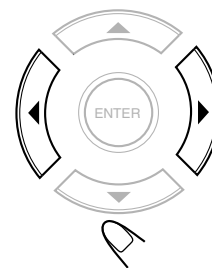

3) Repeat 1) and 2) for setting the other speaker.

Disc Introduction—DVD/VCD/CD

This system has been designed to play back the following discs: DVD, Video CD, Super Video CD (SVCD), Audio CD, CD-R, and CD-RW.

- This system can also play back MP3 files recorded on CD-Rs and CD-RWs. For in-depth information about what MP3, see “MP3 Introduction” on page 43.

Discs you can play:

Disc Type	Mark (Logo)	Video Format*	Region Code Number**
DVD Video		NTSC	1 ALL
Video CD			_____
Super Video CD			_____
Audio CD			_____
CD-R			_____
CD-RW		_____	

- On some DVD or VCD/SVCD discs, their actual operations may be different from what is explained in this manual. This is due to the disc programming and disc structure, but not a malfunction of this system.
- The following discs cannot be played back:
 - DVD-Audio, DVD-ROM, DVD-RAM, DVD-R, DVD-RW, CD-I, (CD-I Ready), Photo CD, etc.
 Playing back these discs will generate noise and damage the speakers.

* Note on Video Format

This unit accommodates the color system of NTSC. Note that the unit cannot playback the disc recorded with the color system of PAL.

If a DVD recorded with the color system of PAL is loaded, “WRONG DISC” appears on the display and playback cannot start.

** Note on Region Code

DVD players and DVD Video discs have their own Region Code numbers. This system only can play back DVD discs whose Region Code numbers include “1.”

Examples:



If a DVD with the inadequate Region Code numbers is loaded, “REGION ERR” appears on the display and playback cannot start.

IMPORTANT:

Before performing any operations, make sure of the following....

- Check the connection with the TV.
- Turn on the TV and select the correct input on the TV to view the pictures or on-screen indications on the TV screen.
- For DVD playback, you can change the Setup menu setting to your preference. (See pages 49 to 53.)

If “⊘” appears on the TV screen when pressing a button, the disc cannot accept an operation you have tried to do, or information required for that operation is not recorded in the disc.
 NOTICE: In some cases, without showing “⊘,” operations will not be accepted.

Disc structure—DVD, Video CD (VCD/SVCD) and Audio CD (CD)

A DVD disc consists of **Titles**, and each title may be divided into some **Chapters**. (See Example 1.)

For example, if a DVD disc contains some movies, each movie may have its own title number, and it may be further divided into some chapters.

On the other hand, a VCD/SVCD or CD consists of **Tracks**. (See Example 2.)

In general, each song has its own track number. (On some discs, each track may also be divided by Indexes.)

When playing back a VCD/SVCD with Playback Control (PBC) function, you can select what to view using the menu shown on the TV screen. (While operating a Video CD using the menu, some of the functions such as Repeat and Track Search may not work.)

Example 1: DVD disc

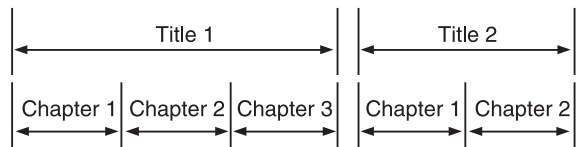

Example 2: Video CD/Audio CD



Notes on CD-R and CD-RW

User-edited CD-Rs (Recordable) and CD-RWs (Rewritable) can be played back only if they are already “finalized.”

- The system can play back CD-Rs or CD-RWs recorded on a personal computer if they have been recorded in the audio CD format or recorded in MP3 format (see page 43). However, they may not be played back depending on their characteristics or recording conditions.
- Before playing back CD-Rs or CD-RWs, read their instructions or cautions carefully.
- Some CD-Rs or CD-RWs may not be played back on this unit because of their disc characteristics, damage or stain on them, or if the built-in lens is dirty.
- CD-RWs may require a longer readout time. This is caused by the fact that the reflectance of CD-RWs is lower than for regular CDs.

Basic Disc Operations

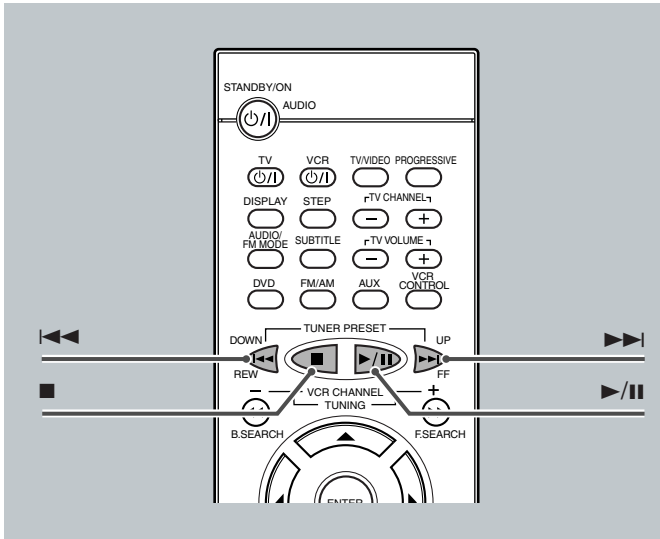

To stop playback for a moment

Press ►/||.

While pausing, minute and second digit of elapsed playing time flashes on the display.

- To resume play, press ►/|| again.

To go to another chapter or track

Press ►► or ◀◀ repeatedly during playback.

- ►► : Skips to the beginning of the next or succeeding chapter or track.
- ◀◀ : While a DVD, a VCD with PBC or MP3 is played back Goes back to the beginning of the previous chapter or track. While a CD or a VCD without PBC is played back Goes back to the beginning of the current or previous track.

To go to another title (only possible on a DVD) or track (only possible on a CD and VCD) directly using the number buttons

Pressing the number buttons before or during play allows you to start playing the title/track number you want. (If your TV is turned on, the on-screen bar is pulled down automatically on the TV screen.)

- To select number 1 to 9, press the corresponding number button (then press ENTER or wait for 5 seconds).
- To select number 15, press 1, 5.
- To select number 23, press 2, 3.

To stop during playback

Press ■.

(If your TV is turned on, “■ STOP” appears on the TV screen.)

- When an MP3 disc is played back, playback stops completely.
- This system can memorize the end point even when you press ■. When you start playback again by pressing ►/||, playback begins from where it has been stopped—Resume play.
- To stop completely, press ■ twice. (“■ STOP” appears on the TV screen.) The disc type appears on the display. The DVD player goes on working for 3 minutes after playback stops.



SVCD can be operated by using the VCD operation procedure.

To start playback

Press ►/||.

The source is automatically changed to the DVD player.

“WAIT” appears on the display for a while, then the detected disc type appears—DVD, VCD, CD, or MP3. (If your TV is turned on, the mark corresponding to the detected disc type appears on the TV screen.)

- When a disc is not loaded, “NO DISC” appears on the display.

Disc play starts from the first chapter or track of the selected disc.

- If a menu appears while playing a DVD or VCD with PBC function, see “Disc Menu-Driven Playback” (for DVD) on page 31 or “Disc Menu-Driven Playback (Only for VCD)” on page 38.

Note:

If “WRONG PARENTAL CODE” appears on the TV screen, Parental Lock is in use. You cannot play back a DVD containing violent scenes or those not suitable for your family members.

To play back such a disc, cancel the Parental Lock. (See page 52.)

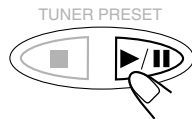

Playback information on the display

DVD

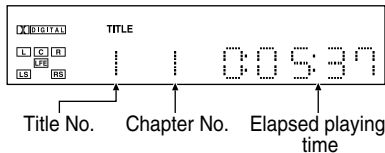

VCD/CD

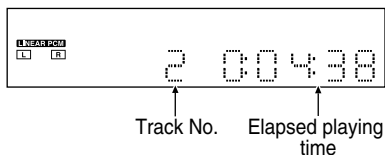

MP3

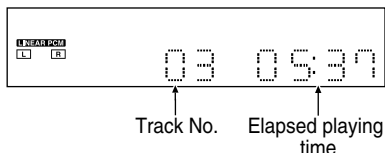

To remove the disc

Press ▲ on the front panel.

The disc tray comes out.

To close the disc tray, press ▲ again.

- If you do not press the button, the disc tray closes automatically 3 minutes after.



DVD Playback

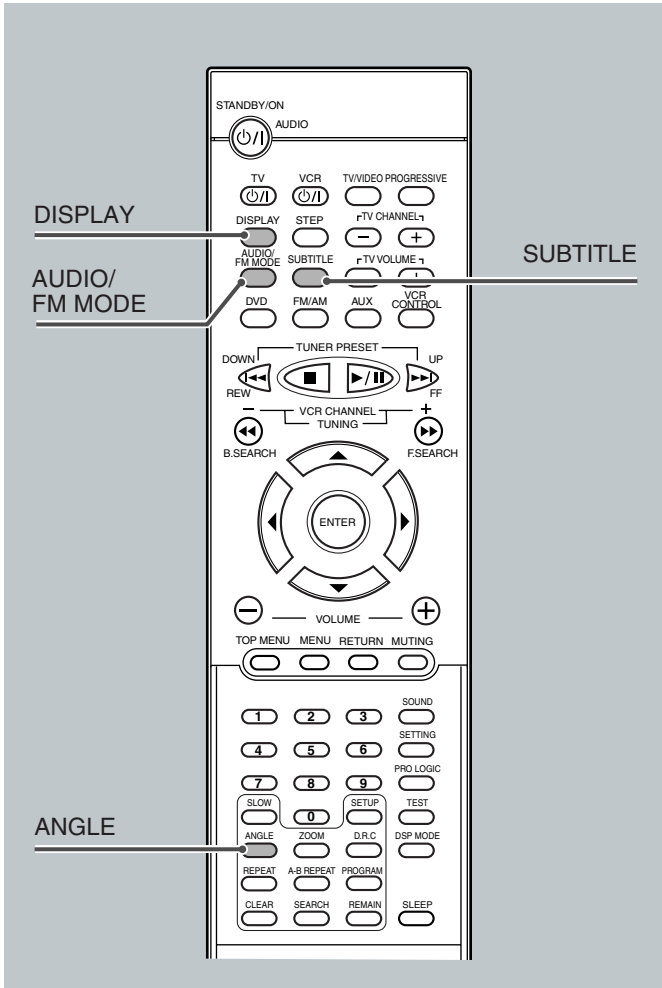

Some DVDs contain several audio languages, subtitles, and multi-angle views. When you find the following marks on the DVD or its package, you can select these elements recorded on the DVD.

	Subtitles are recorded on the disc. The number inside the mark indicates the total number of the recorded subtitles.
	Several audio languages are recorded on the disc. The number inside the mark indicates the total number of the recorded audio languages.
	Multi-angle views are recorded on the disc. The number inside the mark indicates the total number of the recorded multi-angle views.

If you cannot find out whether your disc contains these features listed above, you can check it by showing the on-screen bar.

For basic disc operations such as inserting a disc, starting playback, and moving to another chapters, see “Basic DVD Operations” on pages 12, 13, and “Basic Disc Operations” on page 28.

Showing the On-Screen Bar

You can show the following information on the TV screen while a disc is loaded.

From the remote control ONLY:

Press **DISPLAY**.

- Each time you press the button, the following on-screen bar appears in sequence.



① : Disc type DVD VCD SVCD CD MP3
② : Current title and total number of the titles on the disc • Ex.: 1st title is playing out of 3 titles recorded.
③ : Current chapter and total number of the chapters in the current title • Ex.: 1st chapter is playing out of 5 chapters recorded.
④ : Elapsed playing time or remaining time You can change the play time indication by pressing REMAIN . See page 31 for more details.
⑤ : Subtitle language indication • Ex.: When no subtitle is recorded on the disc. See page 30 for more details.
⑥ : Audio language indication • Ex.: Original sound (default) is selected out of 3 audio languages recorded. See page 30 for more details.
⑦ : Signal format indicator • Signal format type—Linear PCM (stereo), Dolby Digital, and DTS Digital Surround—will be indicated. Ex.: When the disc is encoded with Dolby Digital.
⑧ : Repeat mode indicator • Ex.: When repeat mode is turned off. See page 33 for more details.
⑨ : Multi-angle view indicator • Ex.: When only a single angle-view is recorded on the disc. See page 30 for more details.

Selecting the Subtitles

While playing back a DVD containing subtitles in different languages, you can select the subtitle to be displayed on the TV screen.

- You can set your favorite subtitle language as the initial language shown on the screen. (See page 49.)

From the remote control ONLY:

Press SUBTITLE.

The on-screen bar appears on the TV screen for a while.

- Each time you press the button, the subtitle language changes as follows:

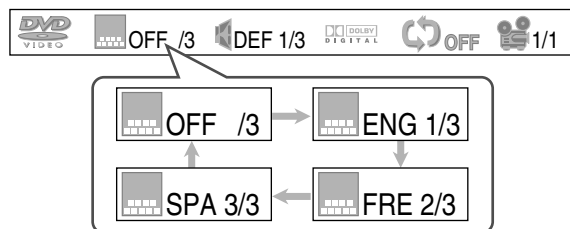

Ex.: When the disc has 3 selections—English, French, Spanish and no subtitle (OFF)

Selecting the Multi-Angle Views

While playing back a DVD containing multi-angle views, you can view the same scene at different angles.

- When you play back the DVD containing multi-angle views,  appears on the TV screen.

From the remote control ONLY:

Press ANGLE.

- Each time you press the button, the view angle changes.

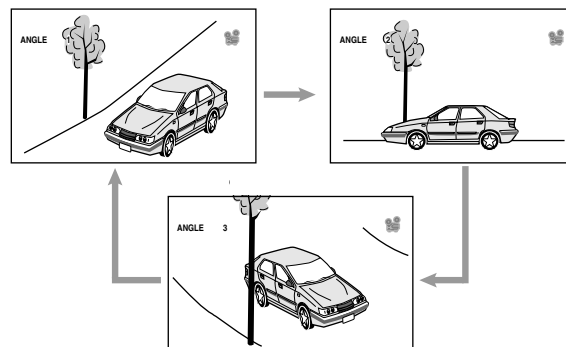

Ex.: When the disc has 3 multi-angle views

Note:

When the on-screen bar is shown on the TV screen, Multi angle view indication also changes as follows:

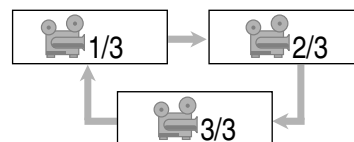

Selecting the Audio Languages

While playing back a DVD containing audio languages (sound track), you can select the language (sound track) to listen to.

- You can set your favorite audio language as the initial audio language. (See page 49.)

Press AUDIO/FM MODE.

The on-screen bar appears on the TV screen for a while.

- Each time you press the button, the audio language changes as follows:

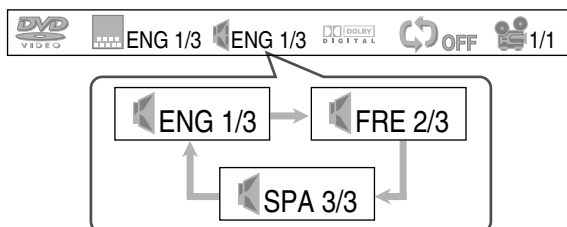

Ex.: When the disc has 3 selections—English, French, and Spanish

DVD Playback

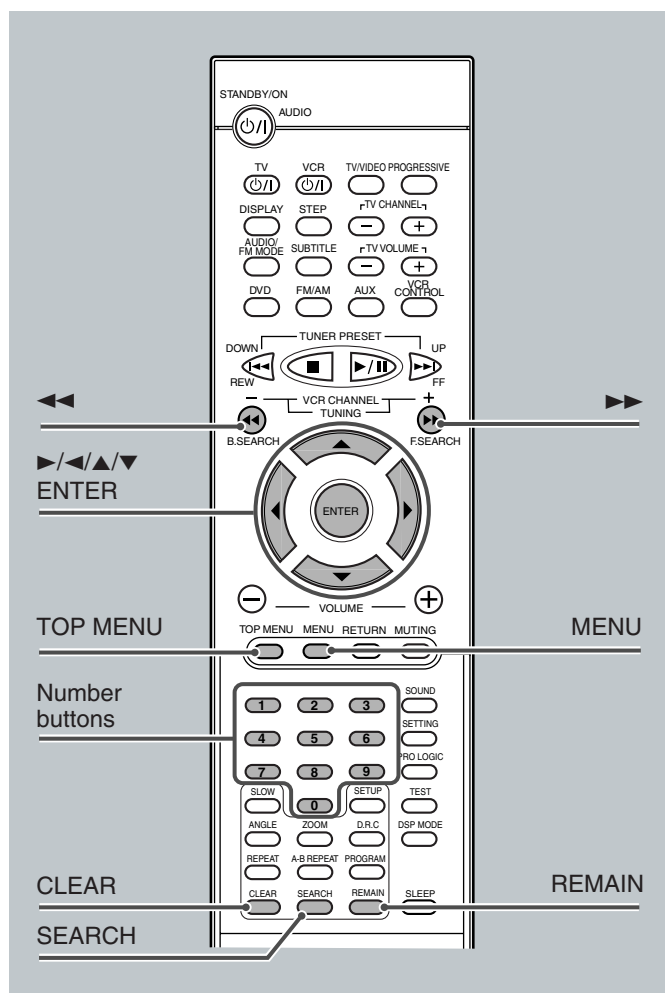

Checking the Remaining Time

While playing back a DVD, you can check the remaining time to be played back.

From the remote control ONLY:

Press **REMAIN**.

The on-screen bar and the current play time indication appear on the TV screen for a while.

- Each time you press the button, the following indication appears on the screen:

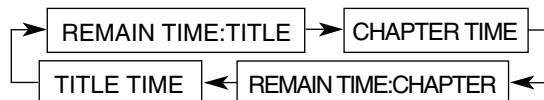

REMAIN TIME:TITLE

: Select this to show the remaining time of the current title.

CHAPTER TIME

: Select this to show the elapsed playing time of the current chapter.

REMAIN TIME:CHAPTER

: Select this to show the remaining time of the current chapter.

TITLE TIME

: Select this to show the elapsed playing time of the current title.

Disc Menu-Driven Playback

Disc menu-driven playback is possible while playing back a DVD with menu (menu may be still pictures or moving pictures depending on the disc).

- When operating a disc using the disc menu, refer also to the instructions supplied for the disc.

DVD discs generally have their own menus or title lists. A menu usually contains various information about the disc and playback selections. On the other hand, a title list usually contains titles of movies and songs recorded.

From the remote control ONLY:

1 Press **MENU** or **TOP MENU**.

A menu or title list will appear on the screen.

“MENU” appears on the display.

- On some DVDs, a menu will automatically appear on the screen after playback starts.

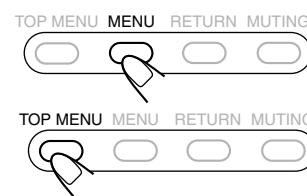

2 Select a desired item on the menu or on the title list, using **▶/◀/▲/▼** and **ENTER**.

The unit starts playback of the selected item.

- On some discs, you can also select items by pressing the number buttons corresponding to the item numbers listed.

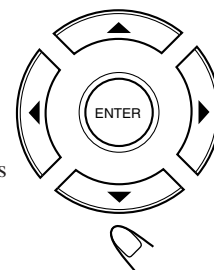

Moving to a Particular Portion Directly

You can move to another title, chapter, or particular scene in the chapter directly.

From the remote control ONLY:

1 Press SEARCH during playback or pause.

- Each time you press the button, the following indication appears on the screen:

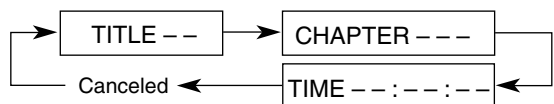

- TITLE --** : Select this to move to another title.
CHAPTER --- : Select this to move to another chapter.
TIME ---:--:-- : Select this to move to a particular scene.

2 Press the number buttons to select a desired title, chapter, or playing time.

The unit starts playback of the selected item. (The on-screen bar appears for a while.)

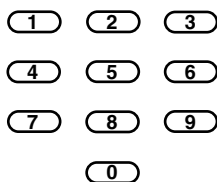

How to input the title and chapter number

Press the number buttons corresponding to the number, then wait for about 5 seconds or press ENTER to start playback.

- To select number 5, press 5, then ENTER.
- To select number 12, press 1, 2, then ENTER.
- To select number 22, press 2, 2, then ENTER.

How to input the playing time

Press the number buttons to input the playing time, then wait for about 5 seconds or press ENTER to start playback at the selected elapsed playing time.

- To input time "00:45:23," press 4, 5, 2, 3.
- To input time "01:23:45," press 1, 2, 3, 4, 5.
- To cancel a mis-entry, press CLEAR.

Each time you press the button, the last entry will be erased.

Note:

When you want to move to another title directly, you can move to it by simply pressing the corresponding number buttons (without pressing SEARCH in step 1).

Searching for a Particular Point

You can search for a particular point while playing a disc—Variable Speed Forward/Reverse Search.

- No sound comes out during Variable Speed Forward/Reverse Search.

To fast-forward the chapter—Variable Speed Forward Search

From the remote control ONLY:

Press ►► during playback or pause.

- Each time you press the button, the search speed changes as follows:

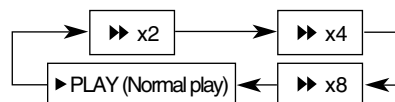

To reverse the chapter—Variable Speed Reverse Search

From the remote control ONLY:

Press ◀◀ during playback or pause.

- Each time you press the button, the search speed changes as follows:

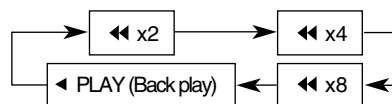

To resume normal play

Press ►/||.

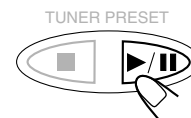

DVD Playback

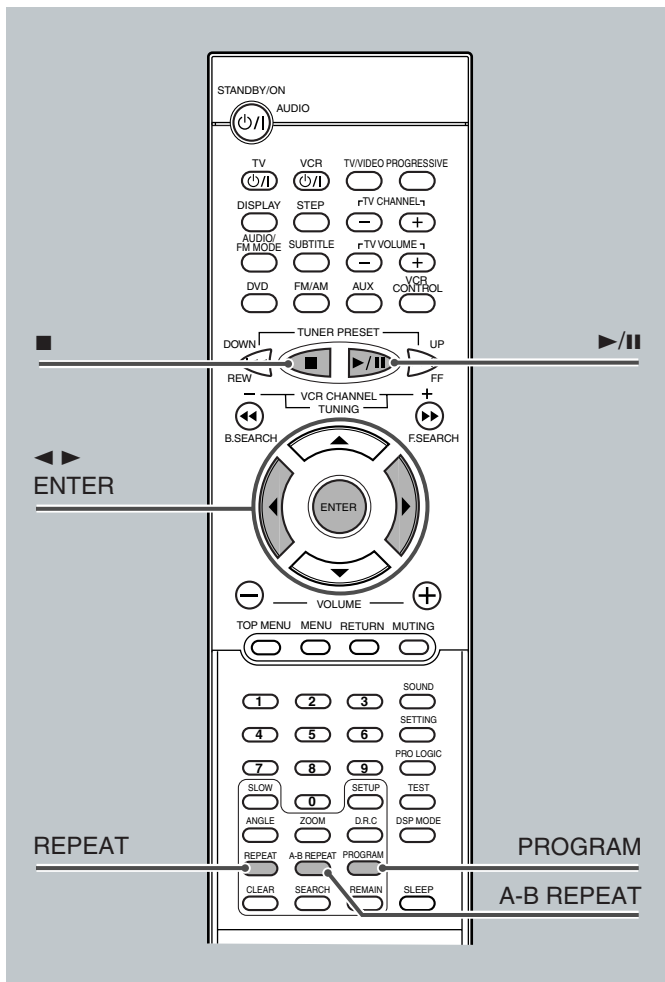

Repeating Playback

Repeat play cannot be used in the following cases:

- When you enjoy program play

Repeat Play

From the remote control ONLY:

Press **REPEAT** repeatedly.

The indication corresponding to the selected mode appears on your TV.

- Each time you press the button, Repeat mode changes as follows:

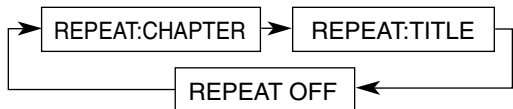

- REPEAT:CHAPTER** : Current chapter will be repeated.
- REPEAT:TITLE** : Current title will be repeated.
- REPEAT OFF** : Repeat play is canceled. (Normal play is resumed.)

Note:

When the on-screen bar is shown on the TV screen, Repeat mode indication also changes as follows:

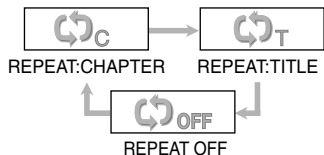

A-B Repeat

While playing, you can also select a portion you want to repeat.

- A-B repeat is not performed between different titles.
- An interval of more than 5 seconds is required between point A and point B.

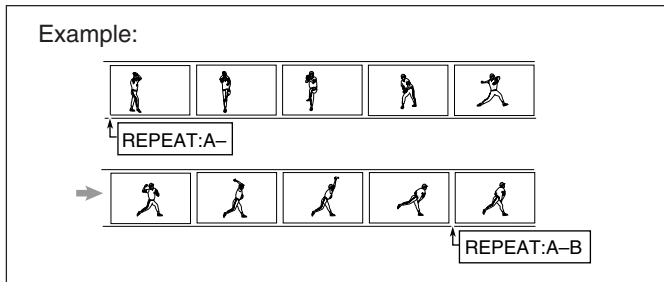

From the remote control ONLY:

1 Press A-B REPEAT to select the start point.

“RPT A-” appears on the display and “REPEAT:A-” appears on the TV-screen.



2 Press A-B REPEAT again to select the end point.

“RPT A-” changes to “RPT A-B” and “REPEAT:A-” changes to “REPEAT:A-B,” then A-B Repeat begins. The unit automatically locates point A and starts repeated playback between points A and B.



To cancel A-B Repeat

Press **A-B REPEAT** again.

“RPT OFF” appears on the display and “REPEAT OFF” appears on the TV-screen.



Note:

When the on-screen bar is shown on the TV screen, Repeat mode indication also changes as follows:

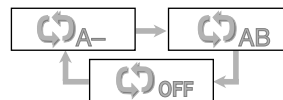

On some DVDs, A-B Repeat may not be used even within the same title. This is due to their disc structures, and not a malfunction of the unit.

Programming the Playing Order of the Chapters—Program Play

You can arrange the chapter playback order before you start playing. You can program up to 20 steps.

- Before making a program, make sure that the TV is turned on and the correct input is selected on the TV.

From the remote control ONLY:

1 Load a disc.

- If the current playing source is not the DVD player, press ►/II, then ■ before going to the next step.

2 Press PROGRAM.

The PROGRAM MENU screen appears on the TV screen.

- “PROGRAM” appears on the display.



PROGRAM MENU		SELECT: ENTER	
TITLE	CHAPT	TITLE	CHAPT
1	-- --	6	-- --
2	-- --	7	-- --
3	-- --	8	-- --
4	-- --	9	-- --
5	-- --	10	-- --

PREVIOUS ↑ NEXT ↓

PLAY: ► FINISH: PROGRAM

3 Press ENTER.

PROGRAM MENU		SELECT: ENTER	
TITLE	CHAPT	TITLE	CHAPT
1	-- --	6	-- --
2	-- --	7	-- --
3	-- --	8	-- --
4	-- --	9	-- --
5	-- --	10	-- --

CHOOSE: 1-5

PREVIOUS ↑ NEXT ↓

PLAY: ► FINISH: PROGRAM

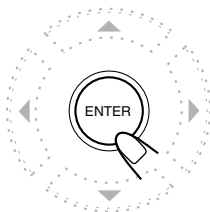

Title numbers you can select in the next step

4 Press ► or ◀ to select a title number, then ENTER.

- ► : Increases the number.
- ◀ : Decreases the number.
- You can also select a title number using the number buttons.

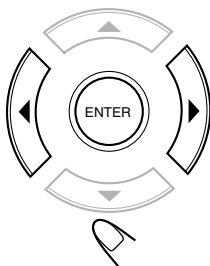

PROGRAM MENU		SELECT: ENTER	
TITLE	CHAPT	TITLE	CHAPT
1	-2 --	6	-- --
2	-- --	7	-- --
3	-- --	8	-- --
4	-- --	9	-- --
5	-- --	10	-- --

CHOOSE: 1-9

PREVIOUS ↑ NEXT ↓

PLAY: ► FINISH: PROGRAM

Chapter numbers you can select in the next step

5 Press ► or ◀ to select a chapter number, then ENTER.

- ► : Increases the number.
- ◀ : Decreases the number.
- You can also select a chapter number using the number buttons.

PROGRAM MENU		SELECT: ENTER	
TITLE	CHAPT	TITLE	CHAPT
1	2 8	6	-- --
2	-- --	7	-- --
3	-- --	8	-- --
4	-- --	9	-- --
5	-- --	10	-- --

PREVIOUS ↑ NEXT ↓

PLAY: ► FINISH: PROGRAM

- To select all chapters in the selected title as one program step, simply press ENTER without selecting any number. “ALL” appears on the chapter number position.

6 Repeat steps 3 to 5 to program other chapters you want.

- After 10 steps are programmed, “NEXT ↓” is selected (highlighted). If you want to program more steps, press ENTER.

7 Press ►/II.

The chapters are played in the order you have programmed and the PROGRAM indicator lights up.

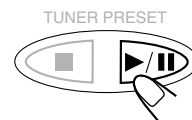

After all the chapters you programmed are played back, the PROGRAM MENU screen appears on the TV screen again.

To stop during playback

Press ■ or PROGRAM on the remote control.

The PROGRAM MENU screen appears on the TV screen.

- If you press ►/II while this screen is shown, the unit starts program play.

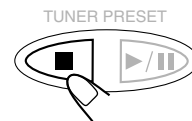

PROGRAM MENU		SELECT: ENTER	
TITLE	CHAPT	TITLE	CHAPT
1	2 8	6	2 2
2	1 5	7	2 12
3	1 17	8	1 9
4	3 6	9	-- --
5	4 2	10	-- --

PREVIOUS ↑ NEXT ↓

PLAY: ► FINISH: PROGRAM

TO BE CONTINUED ON THE NEXT PAGE

DVD Playback

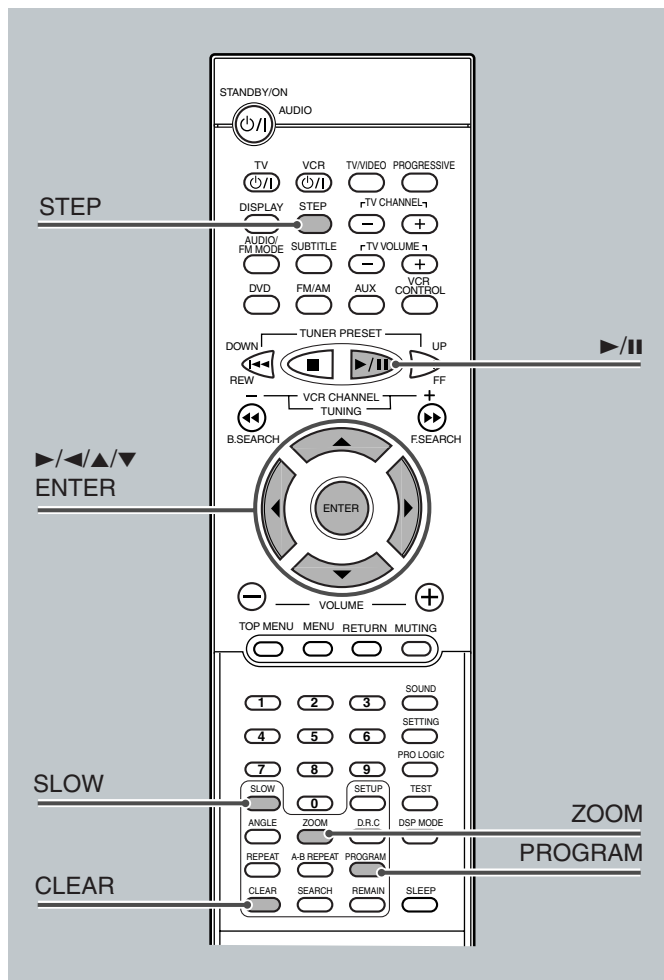

To erase the stored program

Press **▲** to eject the disc.

- If you turn off the system or change the source, the program is also erased.



To check the program contents

You can check the program contents by pressing PROGRAM. The PROGRAM MENU screen appears on the TV screen.

- If you press the button during playback, the program play will stop.

To modify the program

You can modify the program while the PROGRAM MENU screen is shown on the TV screen.

- **To erase a step:** Press **▼** (or **▲**) to select (highlight) an unwanted program step, then press CLEAR.
- **To modify a step:** Press **▼** (or **▲**) to select (highlight) a program step you want to modify, then perform steps **3** to **5** on page 34. (Before entering a new number, press CLEAR repeatedly until “—” appears on the number entry position.)
- **To add a step:** Press **▼** (or **▲**) to select (highlight) an empty program step, then perform steps **3** to **5** on page 34.

- To move to program step 10 from program step 11, press **▲** when program step 11 is selected (highlighted) so that “PREVIOUS **↑**” is selected (highlighted). Then, press ENTER.
- To move to program step 11 from program step 10, press **▼** when program step 10 is selected (highlighted) so that “NEXT **↓**” is selected (highlighted). Then, press ENTER.

To exit from program play

From the remote control ONLY:

Press PROGRAM.

The PROGRAM MENU screen goes off, and the opening screen appears. (The program you made is still kept in memory.)



- If you press **▶/||** while this screen is shown, the unit starts normal playback.



DVD Special Effect Playback

■ Still Picture/Frame-by-Frame Playback

You can advance the still picture frame by frame while playing a DVD.

From the remote control ONLY:

1 Press STEP once during playback.

A still picture appears on the TV screen.

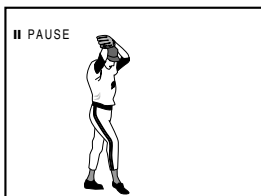

2 Press STEP repeatedly to advance the picture frame by frame.

- Each time you press the button, the picture advances frame by frame.

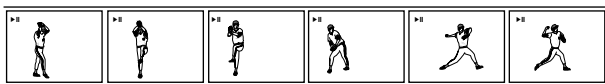

To resume normal play

Press ►/II.

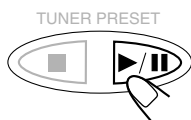

■ Slow Motion Playback

You can enjoy slow motion playback while playing a DVD.

From the remote control ONLY:

Press SLOW repeatedly during playback or pause.

- Each time you press the button, slow motion speed changes as follows:

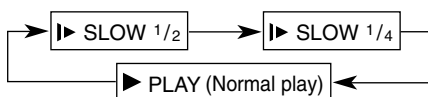

■ Zoom

You can zoom in on the picture while playing back a DVD.

From the remote control ONLY:

1 Press ZOOM to zoom in.

- Each time you press the button, the picture is enlarged as follows:

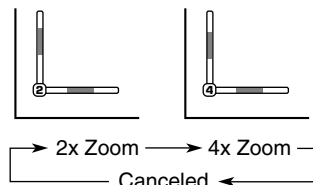

2 Press ►/◀/▲/▼ to move the enlarged portion you want to watch.

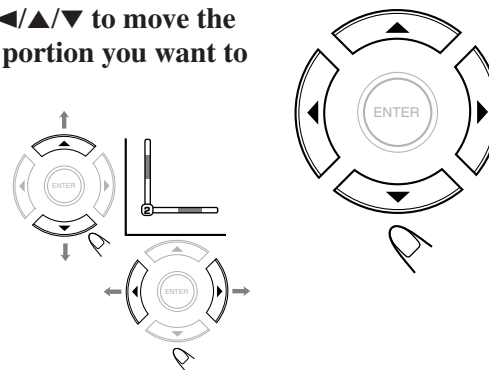

To cancel the ZOOM

Press ZOOM repeatedly until the normal size picture is resumed.



VCD/CD Playback

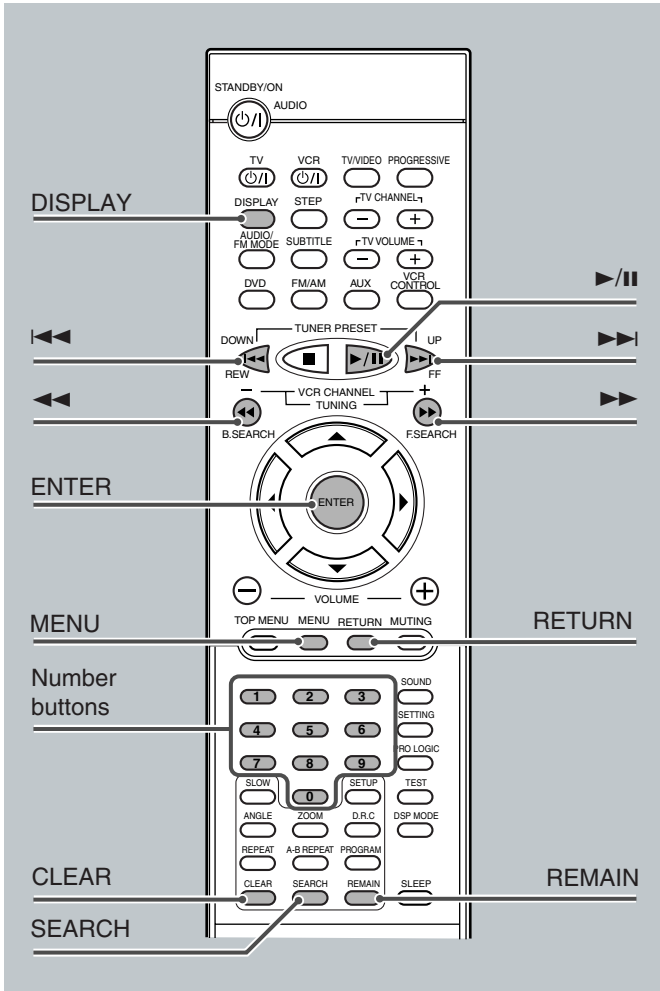

- SVCD can be operated by using the VCD operation procedure.
- For basic disc operations such as inserting a disc, starting playback, and moving to another tracks, see "Basic VCD/CD Operations" on pages 14, 15, and "Basic Disc Operations" on page 28.

Showing the On-Screen Bar

You can show the following information on the TV screen while a disc is loaded.

From the remote control ONLY:

Press **DISPLAY**.

- Each time you press the button, the following on-screen bar appears in sequence.



The on-screen bar shows the following information:

- Disc type (VCD)
- Current track and total number of tracks (T 1/35)
- Sound mode (LR)
- Play Back Control (PBC) indicator (OFF)
- Repeat mode indicator (OFF)
- Elapsed playing time or remaining time (00:12)
- Sound indication (represented by a bar graph)

On-screen bar goes off.

* Appears only when a VCD is loaded.
 ** Appears only when a VCD is played back.

① : Disc type
 DVD DVD VCD VCD SVCD SVCD CD CD MP3 MP3

② : Current track and total number of the tracks on the disc
 • Ex.: 1st track is playing out of 35 tracks recorded.

③ : Sound mode
 • Ex.: Stereo sound (Left channel and Right channel).

④ : Play Back Control (PBC) indicator
 • Ex.: PBC is on. (When PBC is turned off, will appear.)

⑤ : Repeat mode indicator
 • Ex.: When repeat mode is turned off. See page 39 for more details.

⑥ : Elapsed playing time or remaining time
 You can change the play time indication by pressing **REMAIN**. See below.

⑦ : Sound indication
 • Indicates sound input level. (Appears only during playback VCD.)

Checking the Remaining Time

While playing back a VCD or CD, you can check the remaining time.

From the remote control ONLY:

Press **REMAIN**.

The on-screen bar appears on the TV screen for a while.

- Each time you press the button, the play time indication changes as follows:

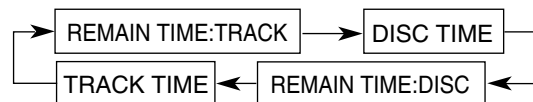

REMAIN TIME:TRACK

: Select this to show the remaining time of the current track.

DISC TIME

: Select this to show the total elapsed playing time of the disc.

REMAIN TIME:DISC

: Select this to show the total remaining time of the disc.

TRACK TIME

: Select this to show the elapsed playing time of the current track.

Disc Menu-Driven Playback (Only for VCD)

The Play Back Control function (PBC) allows you to operate the VCD using menus. When you start playing a VCD with PBC function, a menu will automatically appear on the TV screen. ("MENU" will also appear on the display.)

- A menu may be a list of items, divided screens, or some moving pictures. (See "PBC operation concept" below.)

When a menu appears, you can select a desired item on the menu.

- When a list of items is displayed on the TV screen, press the number buttons to select an item.
- When "▶" or "SELECT" is displayed on the TV screen, press ▶/II to start playback.

To go to the next submenu

Press ▶▶.



To return to the previous submenu

Press ◀◀.



To cancel the PBC playback

You can cancel the menu-driven operations (PBC function):

- 1 Press ■ to stop playback.
- 2 Press the number buttons to select a track.

Normal playback starts from the selected track.

- You can also turn on and off the PBC function by pressing MENU on the remote control. Each time you press the button, the PBC function turns on and off.

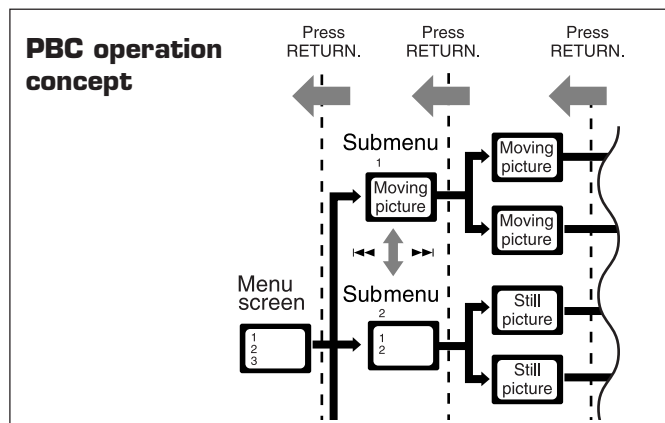

Note:

While operating a VCD using menu, some of the functions such as repeat play may not work.

Moving to a Particular Portion Directly

You can move to a particular portion (scene) on the track directly.

- PBC function is canceled when you use this function.

From the remote control ONLY:

1 Press SEARCH during playback or pause.

- Each time you press the button, the following indication appears on the TV screen.

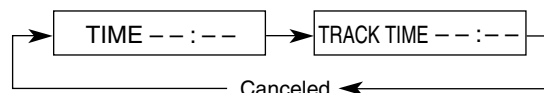

TIME --- : --- : Select this to move to a particular portion on the current disc.

TRACK TIME --- : --- : Select this to move to a particular portion on the current track.

2 Press number buttons to select a playing time you want to search for.

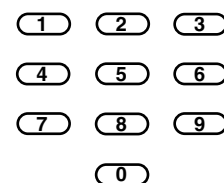

The unit starts playback at the selected elapsed playing time. (The on-screen bar appears for a while.)



- To input time "45:23," press 4, 5, 2, 3.
- To input time "09:45," press 9, 4, 5, then wait for about 5 seconds (or press ENTER).
- To cancel a misentry, press CLEAR. Each time you press the button, the last entry will be erased.

Searching for a Particular Point

You can search for a particular point while playing a disc—Variable Speed Forward/Reverse Search.

- No sound comes out during Variable Speed Forward/Reverse Search on a VCD.

To fast-forward the tracks—Variable Speed Forward Search

Press ▶▶ during playback or pause.

- Each time you press the button, the search speed changes as follows:

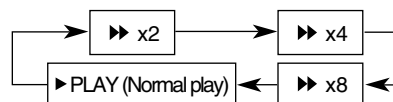

To reverse the tracks—Variable Speed Reverse Search

Press ◀◀ during playback or pause.

- Each time you press the button, the search speed changes as follows:

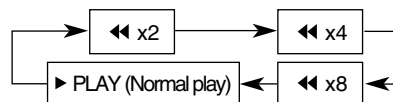

VCD/CD Playback

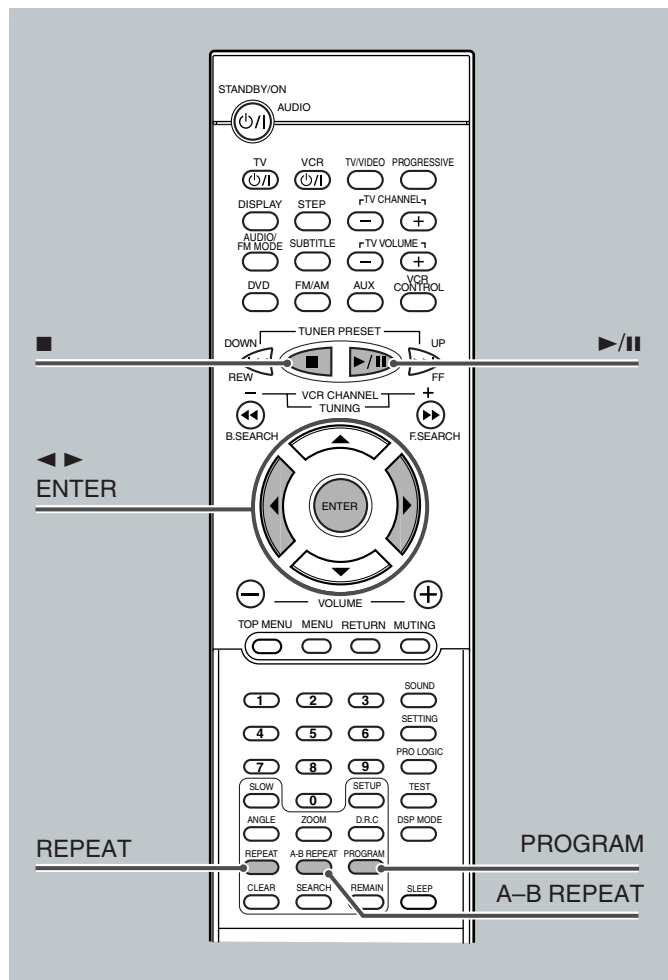

Repeating Playback

Repeat play cannot be used in the following cases:

- When you play back a VCD using the PBC function
- When you enjoy program play

Repeat Play

From the remote control ONLY:

Press **REPEAT** repeatedly.

The indication corresponding to the selected mode appears on your TV.

- Each time you press the button, repeat mode changes as follows:

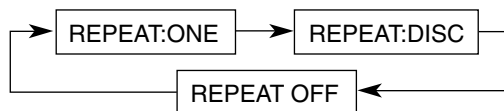

- REPEAT:ONE** : Current track will be repeated.
- REPEAT:DISC** : All the tracks will be repeated.
- REPEAT OFF** : Repeat play is canceled. (Normal play is resumed.)

Note:

When the on-screen bar is shown on the screen, Repeat mode indication also changes as follows:

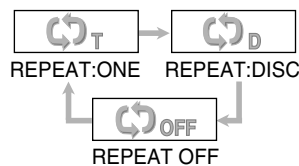

A-B Repeat

While playing, you can also select a portion you want to repeat.

- An interval of more than 5 seconds is required between point A and point B.

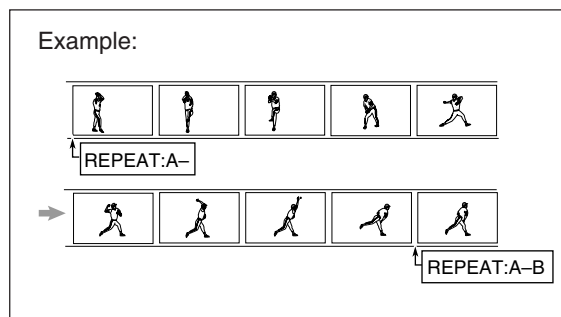

From the remote control ONLY:

1 Press **A-B REPEAT** to select the start point.

“RPT A-” appears on the display and “REPEAT:A-” appears on the TV-screen.



2 Press **A-B REPEAT** again to select the end point.

“RPT A-” changes to “RPT A-B” and “REPEAT:A-” changes to “REPEAT:A-B,” then A-B Repeat begins.

The unit automatically locates point A and starts repeated playback between points A and B.



To cancel A-B Repeat

Press **A-B REPEAT** again.

“RPT OFF” appears on the display and “REPEAT OFF” appears on the TV-screen.



Note:

When the on-screen bar is shown on the TV screen, Repeat mode indication also changes as follows:

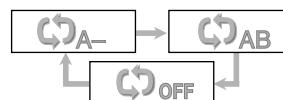

Programming the Playing Order of the Tracks—Program Play

You can arrange the track playback order before you start playing. You can program up to 20 steps.

- Before making a program, make sure that the TV is turned on and the correct input is selected on the TV.

From the remote control ONLY:

1 Load a disc.

- If the current playing source is not the DVD player, press ►/||, then ■ before going to the next step.

2 Press PROGRAM.

The PROGRAM MENU screen appears on the TV screen.

- “PROGRAM” appears on the display.

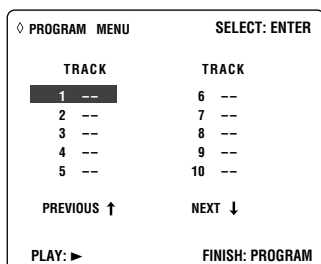

3 Press ENTER.

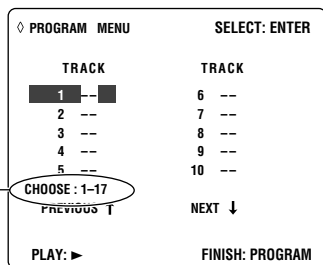

Track numbers you can select in the next step

4 Press ► or ◀ to select a track number, then ENTER.

- ► : Increases the number.
- ◀ : Decreases the number.
- You can also select a track number using the number buttons.

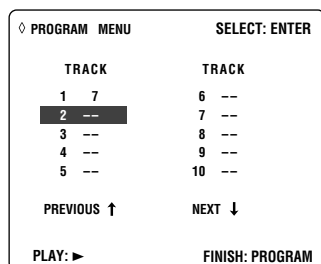

5 Repeat steps 3 and 4 to program other tracks you want.

- After 10 steps are programmed, “NEXT ↓” is selected (highlighted). If you want to program more steps, press ENTER.

6 Press ►/||.

The tracks are played in the order you have programmed and the PROGRAM indicator lights up.

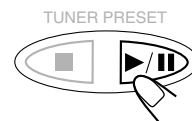

After all the tracks you programmed are played back, the PROGRAM MENU screen appears on the TV screen again.

To stop during play

Press ■ or PROGRAM on the remote control.

The PROGRAM MENU screen appears on the TV screen.

- If you press ►/|| while this screen is shown, the system starts program play.

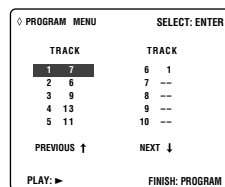
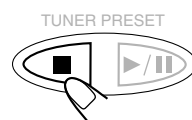

To exit from program play

From the remote control ONLY:

Press PROGRAM.

The PROGRAM MENU screen goes off, and the opening screen appears. (The program you made is still kept in memory.)

- If you press ►/|| while this screen is shown, the unit starts normal playback.



To erase the stored program

Press ▲ to eject the disc.

- If you turn off the system or change the source, the program is also erased.

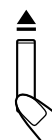

To check the program contents

You can check the program contents by pressing PROGRAM. The PROGRAM MENU screen appears on the TV screen.

- If you press the button during playback, the program play will stop.



TO BE CONTINUED ON THE NEXT PAGE

VCD/CD Playback

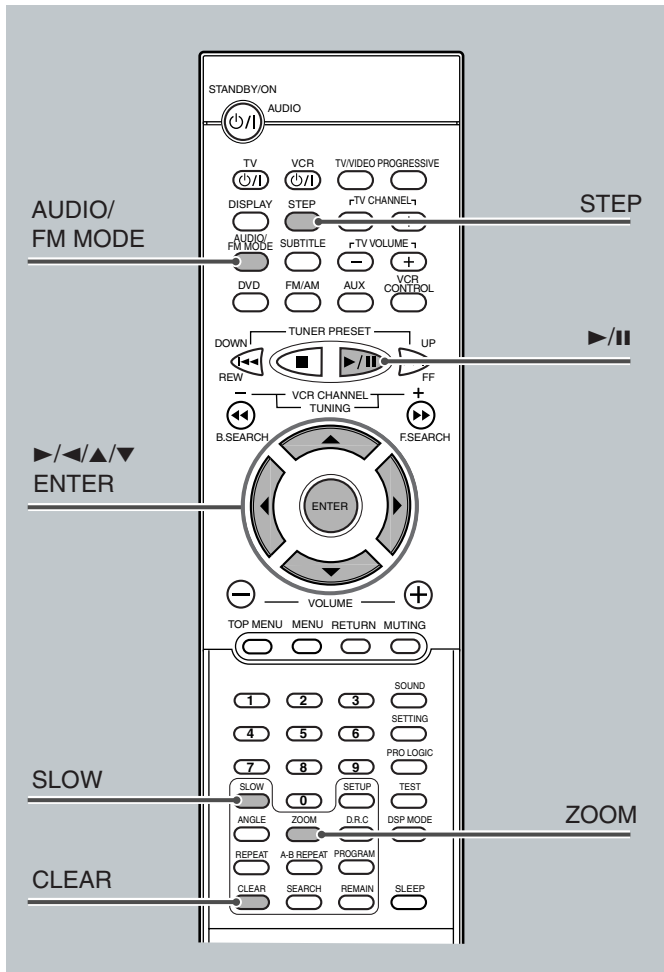

To modify the program

You can modify the program while the PROGRAM MENU screen is shown on the TV screen.

- **To erase a step:** press ▼ (or ▲) to select (highlight) an unwanted program step, then press CLEAR.
- **To modify a step:** press ▼ (or ▲) to select (highlight) a program step you want to modify, then perform steps **3** and **4**. (Before entering a new number, press CLEAR repeatedly until “-” appears on number entry position.)
- **To add a step:** press ▼ (or ▲) to select (highlight) an empty program step, then perform steps **3** and **4**.

- To move to program step 10 from program step 11, press ▲ when program step 11 is selected (highlighted) so that “PREVIOUS ↑” is selected (highlighted). Then, press ENTER.
- To move to program step 11 from program step 10, press ▼ when program step 10 is selected (highlighted) so that “NEXT ↓” is selected (highlighted). Then, press ENTER.

Selecting Playback Channel

When you play back a karaoke VCD or CD, you can only select either the left channel or right channel to listen to.

Press **AUDIO/FM MODE** repeatedly.

The on-screen bar appears on the screen for a while.

- Each time you press the button, the sound mode changes as follows:

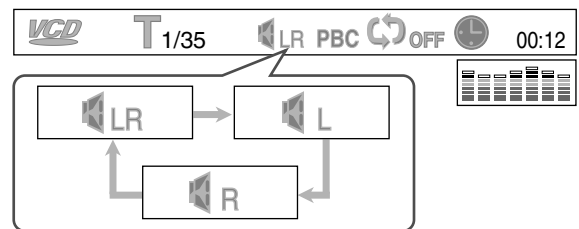
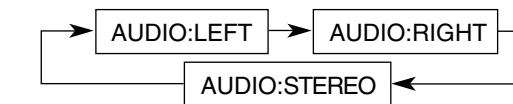

- AUDIO:STEREO (LR)** : Select this to listen to both channel sounds.
- AUDIO:LEFT (L)** : Select this to listen to the left channel sounds.
- AUDIO:RIGHT (R)** : Select this to listen to the right channel sounds.

REMEMBER that after playing back a karaoke VCD or CD using “AUDIO:LEFT” or “AUDIO:RIGHT,” select “AUDIO:STEREO” to restore normal stereo playback.

VCD Special Effect Playback

■ Still Picture/Frame-by-Frame Playback

You can advance the still picture frame by frame while playing a VCD.

From the remote control ONLY:

1 Press STEP once during playback.

A still picture appears on the TV screen.

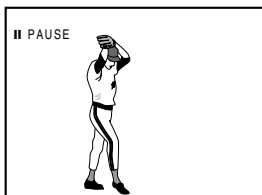

2 Press STEP repeatedly to advance the picture frame by frame.

- Each time you press the button, the picture advances frame by frame.



To resume normal play

Press ►/II.



■ Slow Motion Playback

You can enjoy slow motion playback while playing a VCD.

From the remote control ONLY:

Press SLOW repeatedly during playback or pause.

- Each time you press the button, slow motion speed changes as follows:

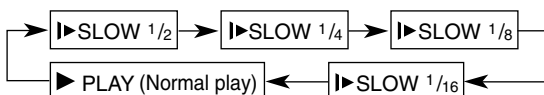

■ Zoom

You can zoom in on the picture while playing a VCD.

From the remote control ONLY:

1 Press ZOOM to zoom in.

- Each time you press the button, the picture is enlarged as follows:

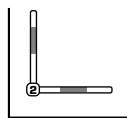

2x Zoom ←→ Canceled

2 Press ►/◀/▲/▼ to move the enlarged portion you want to watch.

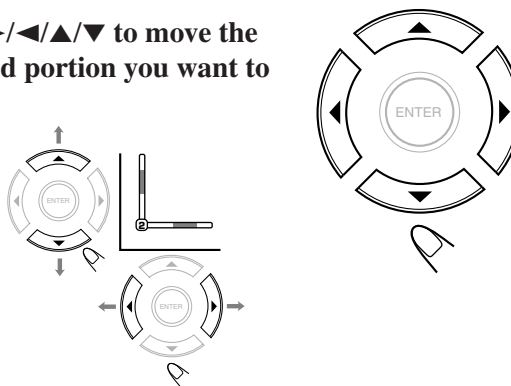

To cancel the ZOOM

Press ZOOM again.

The normal size picture is resumed.



MP3 Introduction

This system is incorporated with an MP3 decoder. You can play back MP3 tracks (files) recorded on CD-Rs, and CD-RWs.

- Notice that “files” and “tracks” are used interchangeably.

What is MP3?

MP3 is an abbreviation of Motion Picture Experts Group (or MPEG) Audio Layer 3. MP3 is simply a file format with a data compression ratio of 1:10 (128 Kbps*). That means, by using MP3 format, one CD-R or CD-RW can contain 10 times as much data volume as a regular CD can.

* Bit rate is the average number of bits that one second of audio data will consume. The measuring unit used is Kbps (1000 bits per second).

To get a better audio quality, choose a higher bit rate. The most popular bit rate for encoding (recording) is 128 Kbps.

MP3 File Compatibility

- This system can only read MP3 files that are recorded in the format that is compliant with ISO 9660 Level 1 or Level 2.
- The system can read or play MP3 files only with the extension code—“.mp3”.
- ID3* tags cannot be shown on the display.
- * An MP3 file can contain file information called “ID3 Tag” where its album name, performer, track title, etc. are recorded. There are two versions—ID3v1 (ID3 Tag version 1) and ID3v2 (ID3 Tag version 2).

Disc structure—How are MP3 files recorded and played back?

“MP3 files (tracks)” can be recorded in “directories (or folders),” in PC terminology.

During recording, the files and directories can be arranged in a way similar to arranging files and folder/directories of computer data.

“Root” is similar to the root of a tree. Every file and directory can be linked to the root.

In compliance with ISO 9660, the maximum allowable depth of nested directories—so-called “hierarchy”—is eight (inclusive of the root).

Playback order, files search order, and directory search order of the MP3 files recorded on a disc are determined by the writing (or encoding) application; therefore, playback order may be different from the one you have intended while recording the folders/directories and the files.

Note on MP3 discs

MP3 discs (either CD-R or CD-RW) require a longer readout time. (It differs due to the complexity of the directory/file configuration.)

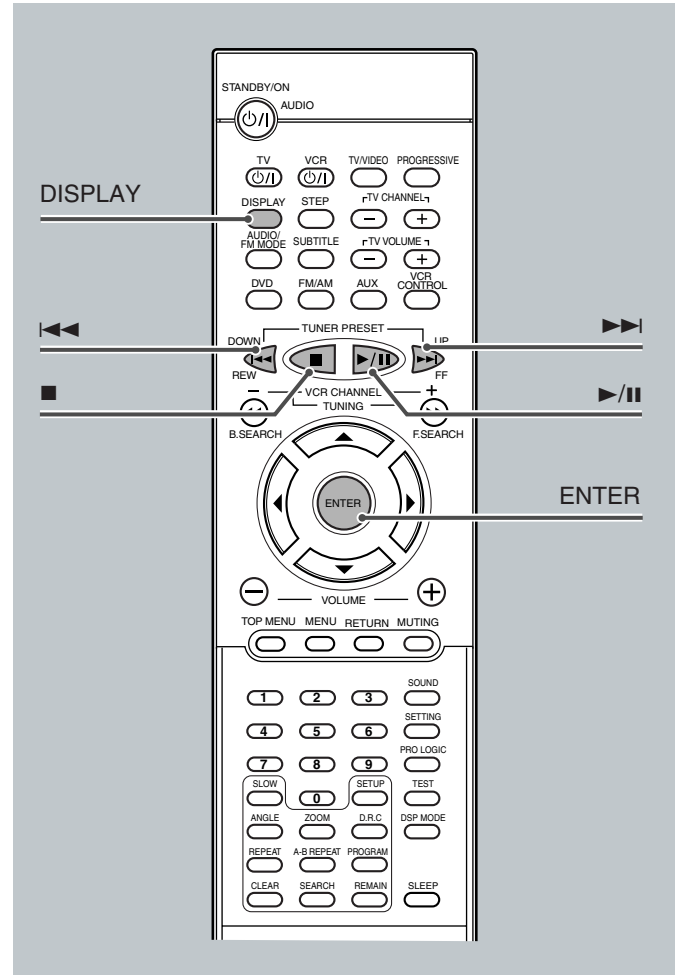

For in-depth information about a disc to be played back, see “Disc Introduction—DVD/VCD/CD” on page 27.

Starting Playback

It is recommended to turn on your TV when playing back an MP3 disc.

1 Press **▲** to load a disc.



2 Press **▶/||**.

- After detecting the disc, playback starts.
- The on-screen bar and the contents recorded on the MP3 disc will be shown on the TV if it is turned on.

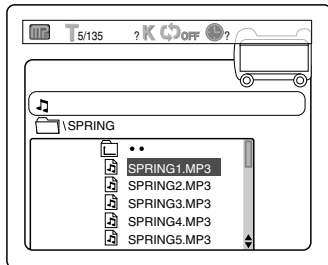
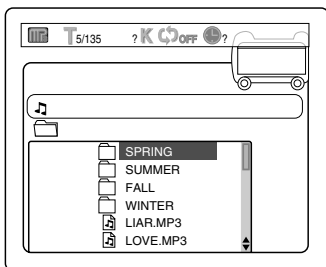

Note:

If the loaded disc is not recorded in the audio CD format or MP3 format, "WRONG DISC FORMAT" appears on the TV screen.

The on-screen bar

①	②	③	④	⑤	⑥
<p>① : Disc type DVD VCD SVCD CD MP3 </p>					
<p>② : Current track (file) and total number of the tracks on the disc • Ex.: 1st track is playing out of 35 tracks recorded.</p>					
<p>③ : Bit rate • Ex.: Bit rate used for recording the loaded disc is 128 Kbps. (See the previous page.)</p>					
<p>④ : Repeat mode indicator • Ex.: When repeat mode is turned off. See page 46 for more details.</p>					
<p>⑤ : Elapsed playing time and the total playing time of the current track</p>					
<p>⑥ : Sound indication • Indicates sound input level. (Only appears during playback.)</p>					

To go to another track

Press **▶▶** or **◀◀** during playback.

- ▶▶** : Skip to the beginning of the next track.



- ◀◀** : Skip to the beginning of the previous track.



To stop playback for a moment

Press **▶/||**.

To resume play, press **▶/||** again or **ENTER**.

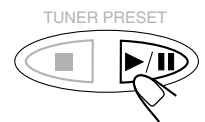

To stop during playback

Press **■**.



To remove the disc

Press **▲** on the front panel.
The disc tray comes out.

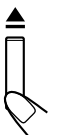

To close the disc tray, press **▲** again.

MP3 Playback

Operations Using the On-Screen Display

It is recommended to turn on your TV when playing back an MP3 disc.

When the loaded MP3 disc is recognized, the following on-screen display appears on the TV screen. (The contents of this on-screen display varies according to the disc—the way MP3 tracks were recorded on the disc.)

- Only the first 8 letters of the titles appear on the TV screen.

From the remote control ONLY:

Button	To do
ENTER	Start playback or go into a directory.
▼ / ▲	Select a track or directory.

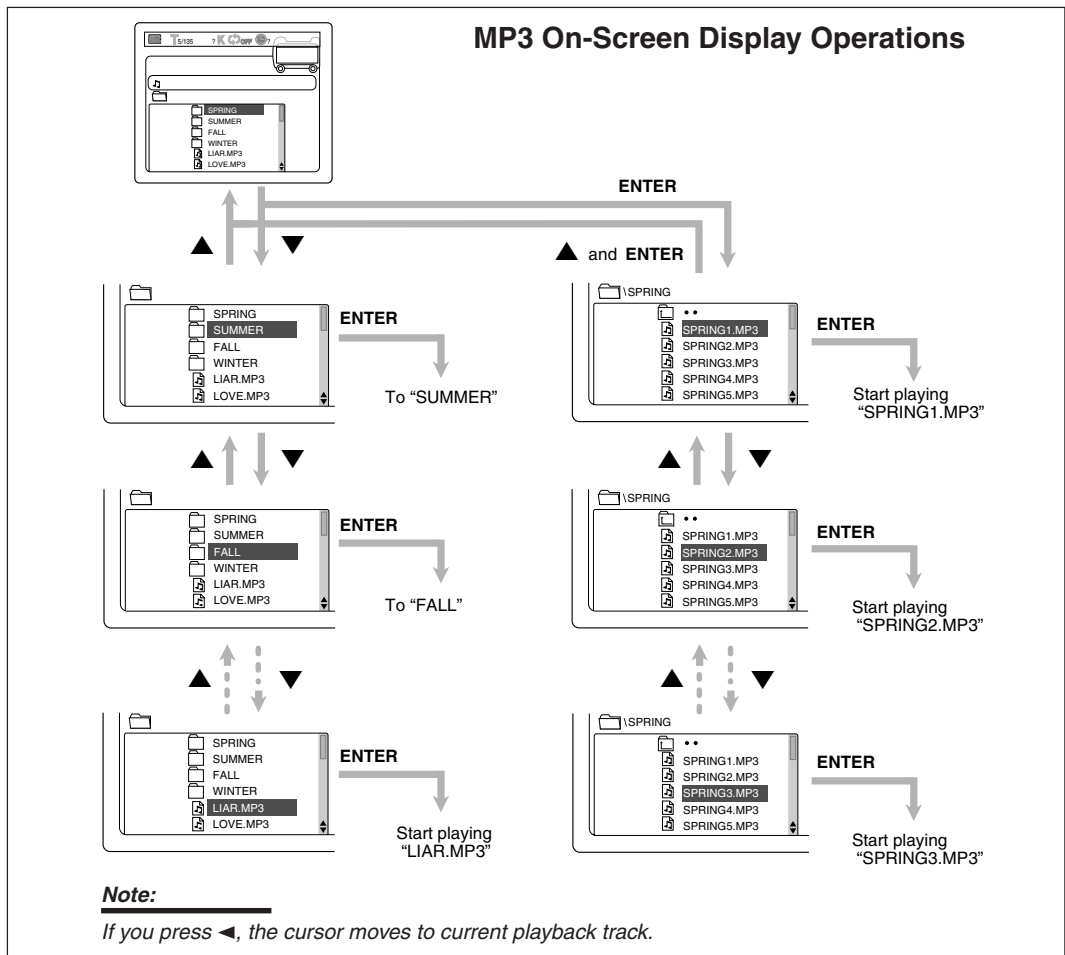
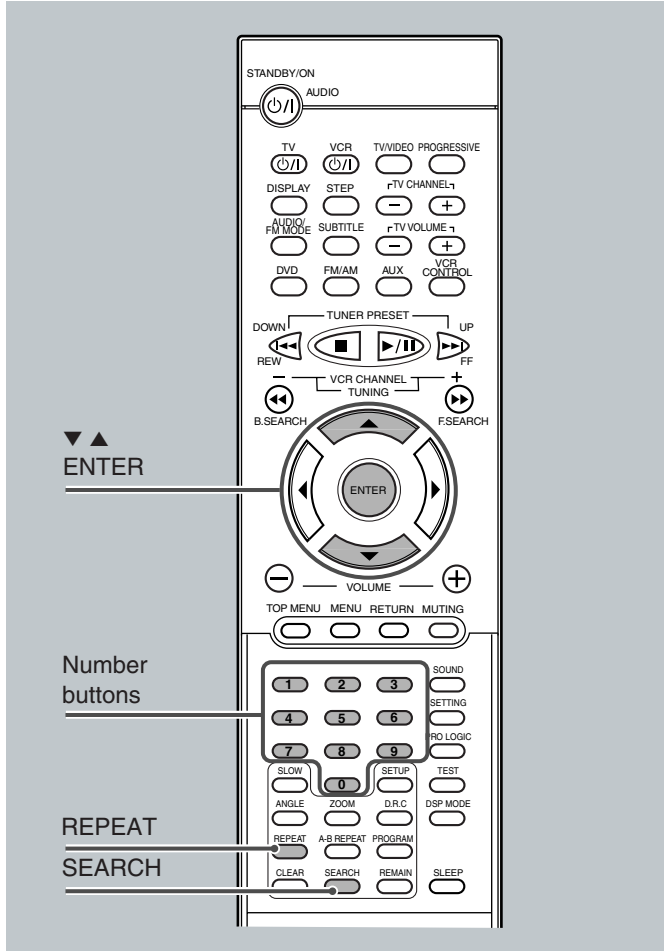

Moving to a Particular Track Directly

You can move to a particular track on the disc directly.

From the remote control ONLY:

1 Press SEARCH during playback or pause.

“TRACK ----” appears on the TV screen.



2 Press the number buttons to select a track number you want.

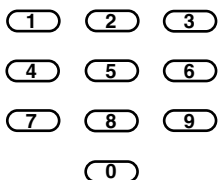

The system starts playback from the selected track.

- To select number 5, press 5 (then ENTER).
- To select number 10, press 1, 0 (then ENTER).
- To select number 23, press 2, 3 (then ENTER).
- To select number 123, press 1, 2, 3.



Note:

When you want to move to another file (track) directly, you can move to it simply by pressing the number buttons (without pressing SEARCH in step 1).

Repeating Playback

On an MP3 disc, A–B Repeat cannot be used. You can enjoy only Repeat play.

To repeat playback—Repeat Play

Press REPEAT repeatedly.

The indication corresponding to the selected mode appears on the TV screen.



- Each time you press the button, repeat mode changes as follows:

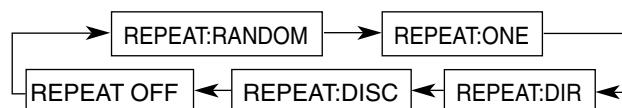

REPEAT:RANDOM

: All tracks recorded on the disc will be played once at random (random play), and random play will be repeated.

REPEAT:ONE

: Current track will be repeated.

REPEAT:DIR

: Tracks in the current directory will be repeated.

REPEAT:DISC

: All tracks on the disc will be repeated.

REPEAT OFF

: Repeat play is canceled. (Normal play is resumed.)

Note:

When the on-screen bar is shown on the TV screen, Repeat mode indication also changes as follows:

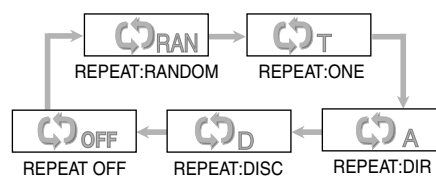

Tuner Operations

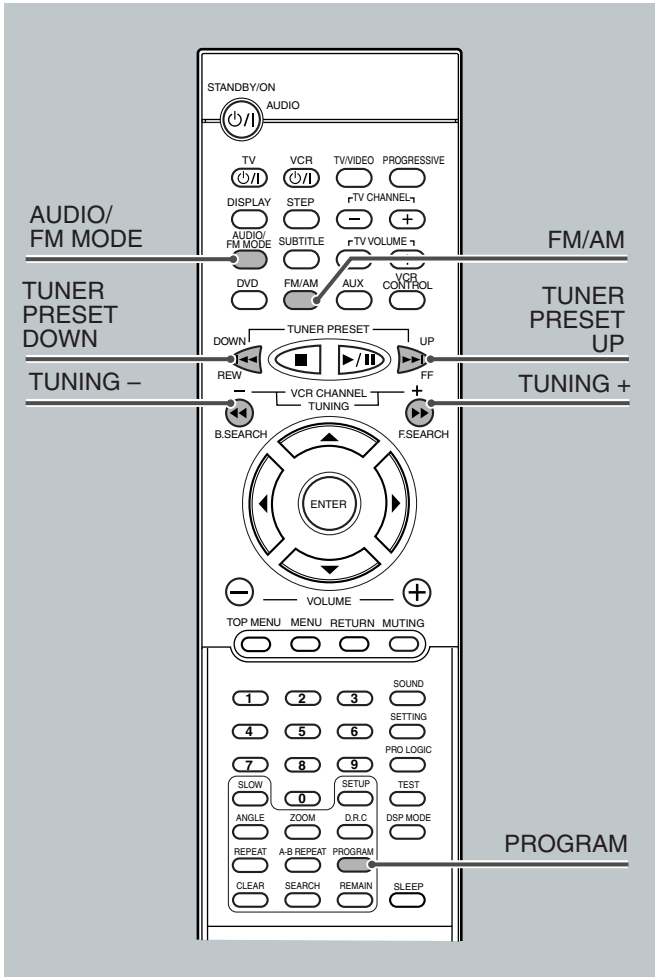

For basic tuner operations, see "Basic Tuner Operations" on page 16.

Tuning in Stations

From the remote control:

1 Press FM/AM repeatedly to select the band.

The last received station of the selected band is tuned in.

- Each time you press the button, the band alternates between FM and AM.



2 Press and hold TUNING + or - until you find the frequency you want.

- TUNING + : Increases the frequency.
- TUNING - : Decreases the frequency.

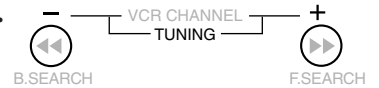

The system starts searching for stations and stops when a station of sufficient signal strength is tuned in.

On the front panel:

1 Press SOURCE repeatedly until the desired band appears on the display.

The last received station of the selected band is tuned in.

- Each time you press the button, the source changes as follows:

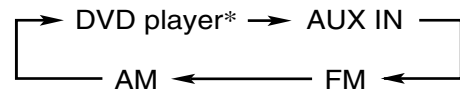

* "WAIT" appears on the display.

2 Press ■ so that "MANUAL" appears on the display.

- Each time you press the button, the operation mode of ►► and ◀◀ buttons alternates between "PRESET" and "MANUAL."



PRESET : Select this for using ►► and ◀◀ as the buttons to select the preset station.

MANUAL : Select this for using ►► and ◀◀ as the buttons to change the frequency manually.

3 Press and hold ►► or ◀◀ until you find the frequency you want.

- ►► : Increases the frequency.
- ◀◀ : Decreases the frequency.



Notes:

- When a station of sufficient signal strength is tuned in, the **TUNED** indicator lights up on the display.
- When an FM stereo program is received, the **ST** indicator also lights up.
- When you press the button repeatedly, the frequency changes step by step.

Using Preset Tuning

Once a station is assigned to a channel number, the station can be quickly tuned. You can preset up to 15 FM and 15 AM stations.

To store the preset stations

From the remote control ONLY:

- 1 Tune in the station you want to preset (see “Tuning in Stations”).

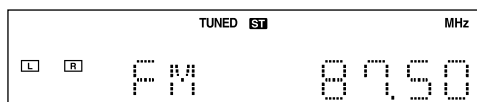

- 2 Press PROGRAM.

The preset number appears on the display and the PROGRAM indicator lights up.

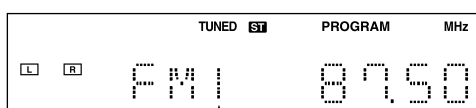

Preset number

- 3 Press TUNER PRESET UP or DOWN to select a preset number.



- TUNER PRESET UP : Increases the preset number.
- TUNER PRESET DOWN : Decreases the preset number.

- 4 Press PROGRAM to store the preset station.

The PROGRAM indicator goes off, and the station is assigned to the selected preset number.



- 5 Repeat steps 1 to 4 until you store all the stations you want.

To erase a stored preset station

Storing a new station on a used number erases the previously stored one.

To tune in a preset station

From the remote control:

- 1 Press FM/AM repeatedly to select the band.

The last received station of the selected band is tuned in.

- Each time you press the button, the band alternates between FM and AM.



- 2 Press TUNER PRESET UP or DOWN until the desired preset station appears on the display.

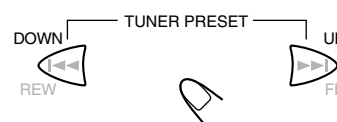

- TUNER PRESET UP : Increases the preset number.
- TUNER PRESET DOWN : Decreases the preset number.

On the front panel:

- 1 Press SOURCE repeatedly until the desired band appears on the display.



- 2 Press ■ so that “PRESET” appears on the display.

- Each time you press the button, the operation mode of ►► and ◀◀ buttons alternates between “PRESET” and “MANUAL.”



PRESET : Select this for using ►► and ◀◀ as the buttons to select the preset station.

MANUAL : Select this for using ►► and ◀◀ as the buttons to change the frequency manually.

- 3 Press ►► or ◀◀ repeatedly until the desired preset station appears on the display.

- ►► : Increases the preset number.
- ◀◀ : Decreases the preset number.



Selecting the FM Reception Mode

When an stereo FM program tuned currently is noisy, you can change the FM reception mode to improve the reception.

Press AUDIO/FM MODE.

The **ST** indicator goes off from the display and the program loses the stereo effect.



To resume the stereo effect, press AUDIO/FM MODE again. The stereo effect resumes.

Note:

The FM reception mode will also resumes in the following cases:

- When you change the frequency, the preset number, or the band
- When you change the source
- When you turn off the system

Setting up the DVD Preferences

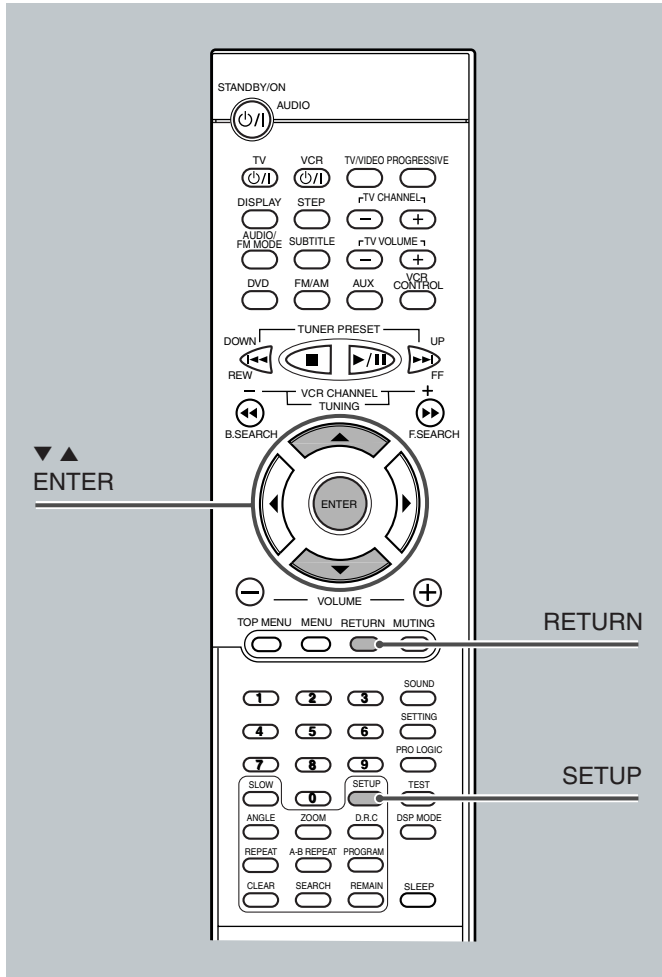

On the Setup menu, you can do the two main important settings—language selection (LANGUAGES) menu and system setting (SYSTEM) menu.

- Setup menu can only be displayed while a disc is not playing. (The DVD player must be selected as the source.)
- You can only use the remote control for Setup menu operations.

Setting the Initial Languages

You can select your favorite language you listen to or read on the TV screen.

When you operate this system or watch a DVD, you will be able to operate the system or to enjoy a DVD in the language you have selected and stored.

On the language selection menu, you can select the following:

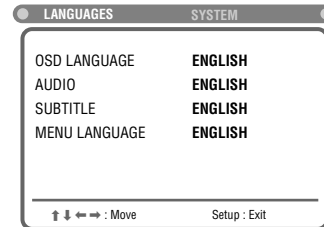

-
- OSD LANGUAGE** : Select the indication language shown on the TV screen while operating the system. (ex. PLAY, STOP, PAUSE, etc.)
-
- AUDIO** : Select the language you listen to while watching a DVD.
-
- SUBTITLE** : Select the subtitle language you read while watching a DVD.
-
- MENU LANGUAGE** : Select the menu language recorded on a DVD which you use while operating the DVD's own menu.
-

Languages you can select on this menu

You can select the following languages separately for each listed item on the menu.

- For “**OSD LANGUAGE**”: English, Chinese, Spanish, French, German, Japanese, and Korean.
- For “**AUDIO**,” “**SUBTITLE**,” and “**MENU LANGUAGE**”: English, Chinese, French, German, Japanese, Russian, Spanish, Portuguese, Korean and Original*.

* Available only for “AUDIO” and “SUBTITLE.”

When you want to operate the disc or enjoy its playback in the originally recorded (default) language, select “ORIGINAL.”

Note:

The original language will be selected as the initial language regardless of your setting in the following cases:

- If the language you have selected is not recorded on the disc.
- If the disc is programmed to be played back in the original language.

Basic language selecting procedure

Ex. : To select the desired language as the initial language for "AUDIO."

From the remote control ONLY:

1 Press SETUP.

Language selection menu of the Setup menu appears on the TV screen.

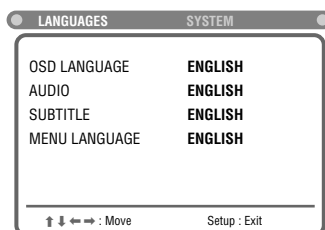

2 Press ▼ (or ▲) to select (highlight) one of the language items.

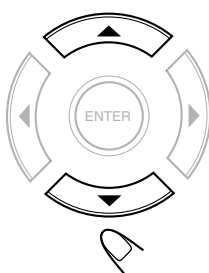
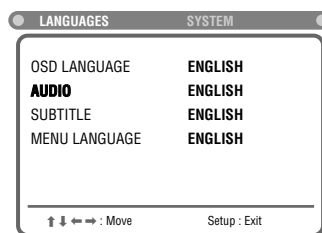

3 Press ENTER.

Pop-up window appears (where the language names are listed).

"✓" indicates the current setting.

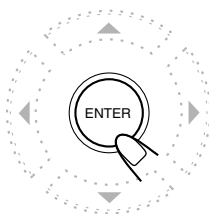
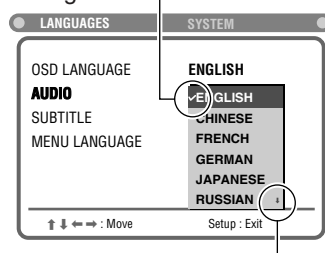

↓ indicates that more languages are listed, but not shown.

4 Press ▼ (or ▲) to select (highlight) the language you want, then press ENTER.

The setting is stored (and the pop-up window goes off).

- When you want to cancel the setting you have just made, press RETURN without pressing ENTER. (Pop-up menu also goes off.)

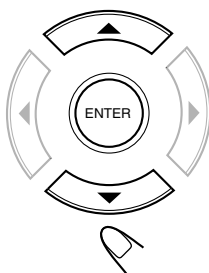

5 Repeat steps 2 to 4 to select the other language items listed.

To erase the Setup menu

Press SETUP.



Introducing the DVD Preference (System)

You can set the DVD preference to match it to your usage and operating circumstances.

On the system setting menu, you can set the following:

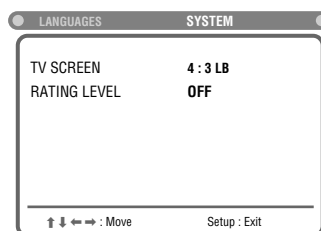

TV SCREEN: Select the TV screen size for playing back a DVD recorded with 16:9 wide screen video signal.

- **4:3 LB** : Select "4:3 LB (Letter Box)" when the aspect ratio of your TV is 4:3. While viewing a wide screen picture, the black bars appear on the top and the bottom of the screen.
- **4:3 PS** : Select "4:3 PS (Pan-Scan)" when the aspect ratio of your TV is 4:3. While viewing a wide screen picture, the black bars do not appear, however, the left and right edge sides of the pictures will not be shown on the screen.
- **16:9** : Select "16:9" when the aspect ratio of the TV is 16:9. (Set the screen size to full on your TV.)

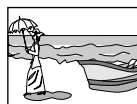
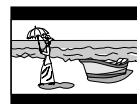

RATING LEVEL: You can select this to restrict playback of DVDs containing violent scenes and those not suitable for your family members. (See page 52 for detailed operations.)

Setting up the DVD Preferences

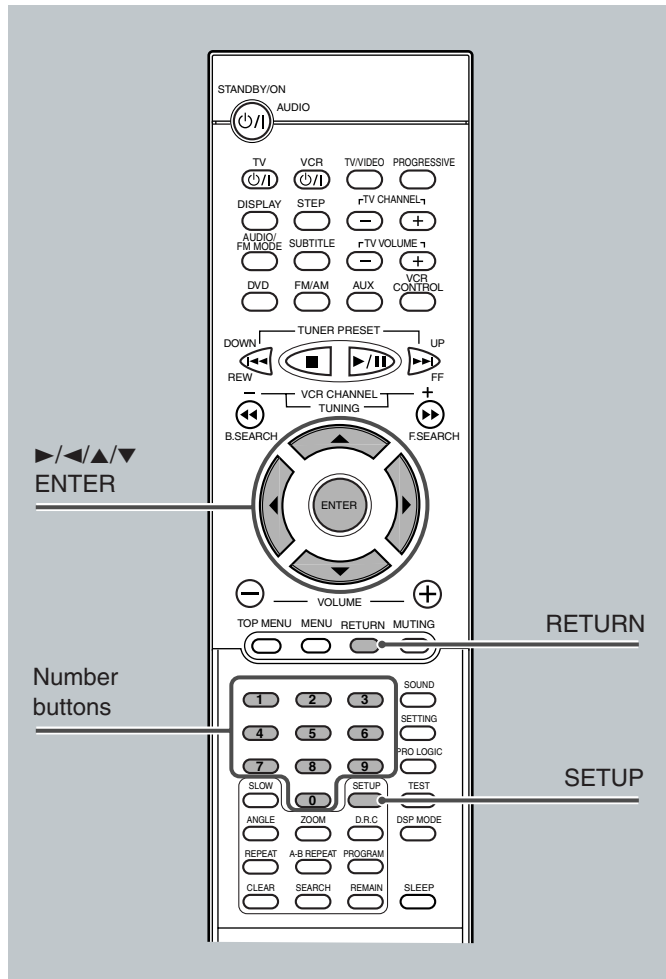

3 Press ▼ (or ▲) to select (highlight) one of the system setting items listed on the menu.

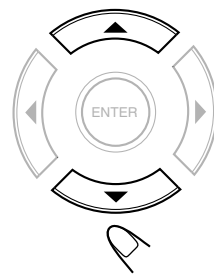
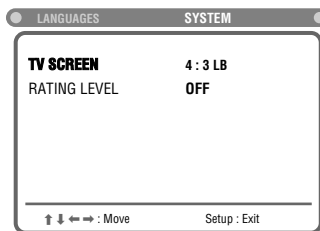

4 Press ENTER.

Pop-up window appears (where the selectable settings are listed).

✓ indicates the current setting.

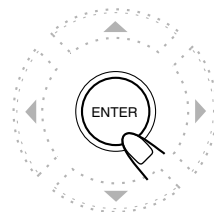
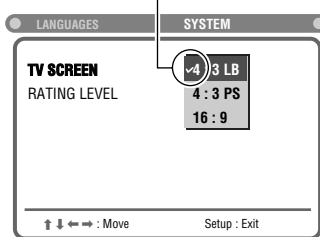

5 Press ▼ (or ▲) to select (highlight) the proper setting, then press ENTER.

The setting is stored (and the pop-up window goes off).

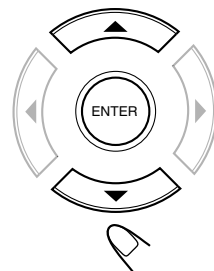

Setting the TV screen size

From the remote control ONLY:

1 Press SETUP.

Language selection menu of the setup menu appears on the TV screen.

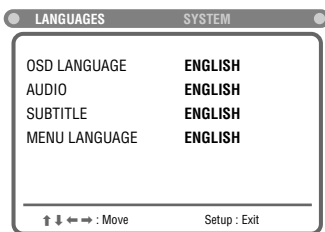

2 Press ENTER (or ►/◄) to select (highlight) the system setting menu.

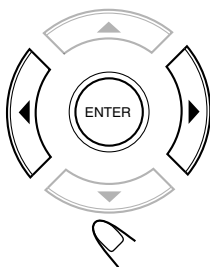
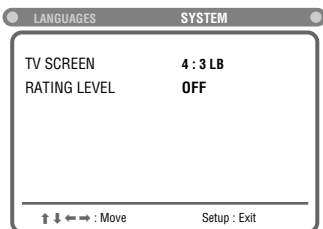

- When you want to cancel the setting you have just made, press RETURN without pressing ENTER. (Pop-up menu also goes off.)

- Even if "4:3 PS" is selected, the screen size may become "4:3 LB" while playing some DVDs. This depends on how the DVD is programmed and recorded.
- If a disc (or some portions of the disc) is recorded with the video signals of 4:3 aspect ratio, this setting does not take effect. The pictures are displayed with full 4:3 aspect ratio or with 4:3 Letter Box.

To erase the Setup menu

Press SETUP.



Setting the Parental (Rating) Level

Using this function, you can restrict playback of DVD containing violent scenes and those not suitable for your family members. Nobody can play such a disc unless this function is canceled. (“WRONG PARENTAL CODE” appears on the display if you try to play back such a disc.)

- This setting takes effect only for the DVDs containing the rating level information—Level 1 (most restrictive) to Level 8 (least restrictive).

From the remote control ONLY:

1 Press SETUP.

Language selection menu of the setup menu appears on the TV screen.



2 Press ENTER (or ►/◄) to select (highlight) the system setting menu.

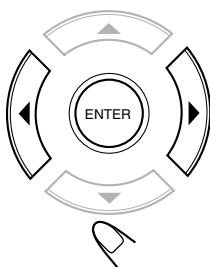
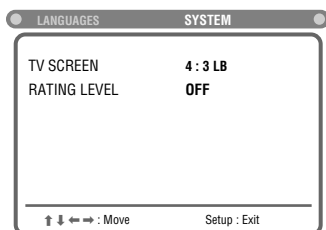

3 Press ▼ (or ▲) to select (highlight) “RATING LEVEL.”

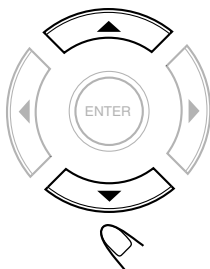
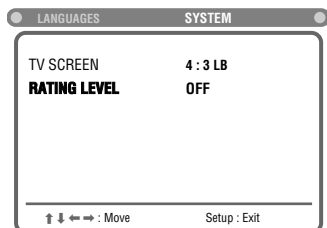

4 Press ENTER.

“RATING LEVEL” now changes to “ENTER PASSWORD” on the menu.

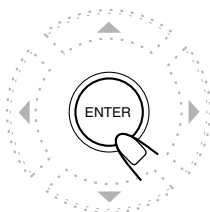
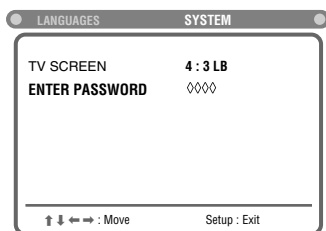

5 Press the number buttons to enter the password (4 digits).

- When shipped from the factory, password is “7890.”
- If you enter a wrong password, your setting will be canceled.

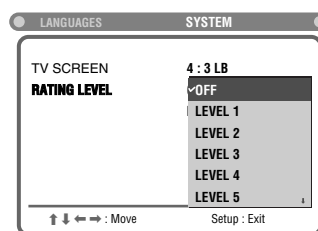
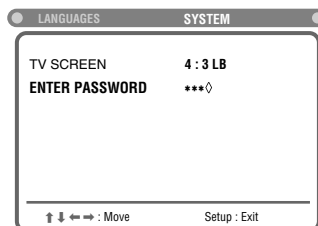

6 Press ▼ (or ▲) to select (highlight) the level you want, then press ENTER.

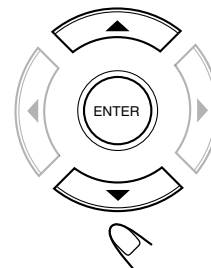

To erase the Setup menu

Press SETUP again.



TO BE CONTINUED ON THE NEXT PAGE

Setting up the DVD Preferences

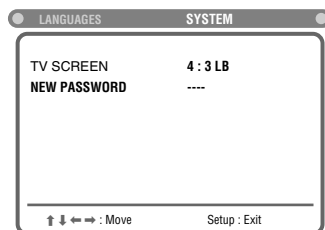
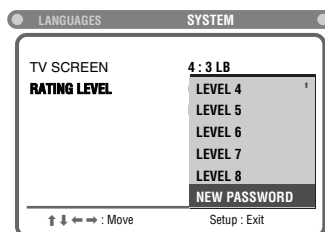
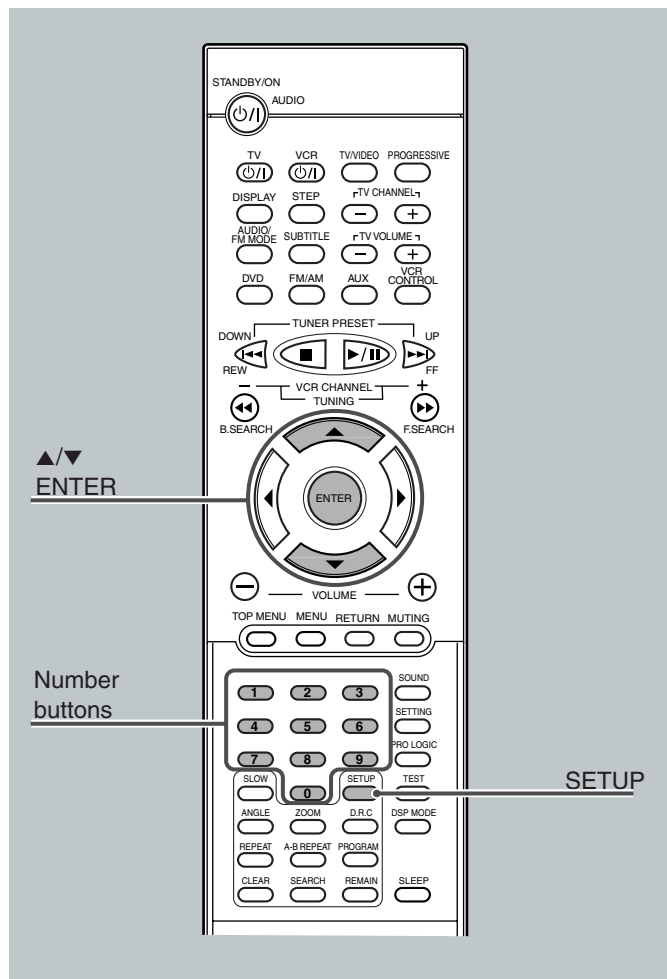

- If “NEW PASSWORD” is the last item listed on the pop-up window and is not shown, pressing ▼ repeatedly will show it in the pop-up window.

3 Press the number buttons to enter a new password, then ENTER.

Your new password is now stored.

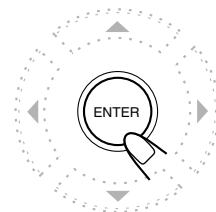

To change the password

1 Repeat steps **1** to **5** of “Setting the Parental (Rating) Level” procedure.

2 Press ▼ (or ▲) to select (highlight) “NEW PASSWORD,” then ENTER.

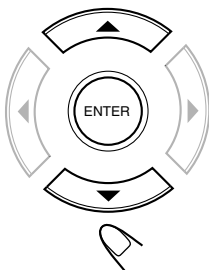

To erase the Setup menu

Press SETUP again.



To reset the password

You can reset the password to the initial setting “7890.”

REMEMBER all the other preset settings such as the speaker settings, preset stations, timer settings, DVD setup menu settings are also reset to the factory settings.

While the source is DVD player and playback stops, press and hold ■ on the front panel until the “INITIAL” appears on the display.

Operating JVC's Components

You can use the remote control to operate not only this unit but also other JVC products.

- Refer also to the manuals supplied for the other products.
 - This remote control can operate a VCR whose remote control code is set to A code.
- To operate the other products, aim the remote control directly at the remote sensor on the target product.

❑ To operate a JVC's TV

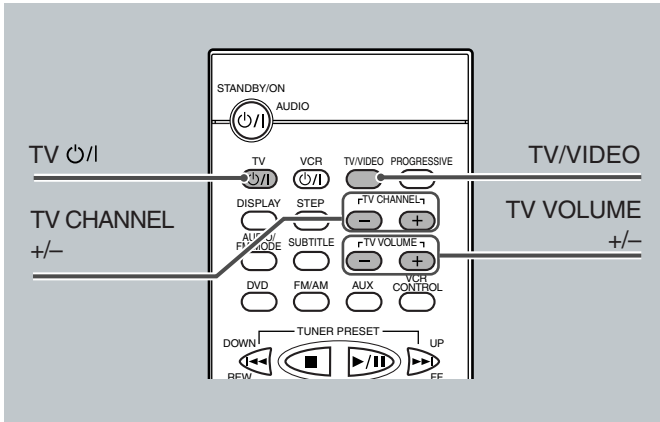

You can perform the following operations on the TV.

TV \odot/I	: Turn on or off the TV.
TV VOLUME +/-	: Adjust the volume.
TV/VIDEO	: Set the input mode (either TV or VIDEO).
TV CHANNEL +/-	: Change the channels.

❑ To operate a JVC's VCR

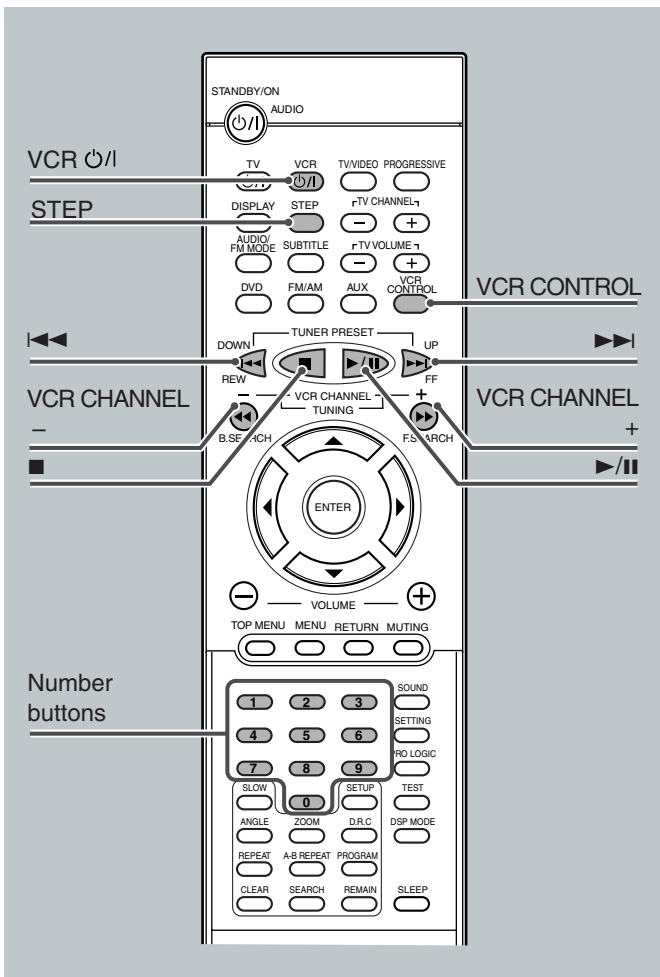

After pressing **VCR CONTROL** on the remote control, you can perform the following operations on the VCR.



VCR \odot/I	: Turn on or off the VCR.
VCR CHANNEL +/-	: Change the channels.
1 - 9, 0	: Select TV channel on the VCR.
$\blacktriangleright/\text{II}$: Start playback.
\blacksquare	: Stop playback.
STEP	: Pause playback. To release it, press $\blacktriangleright/\text{II}$.
FF ($\blacktriangleright\blacktriangleright\text{I}$)	: Fast-wind a tape.
REW ($\blacktriangleleft\blacktriangleleft$)	: Rewind a tape.

After operating the VCR, press **DVD** or **FM/AM**.



IMPORTANT:

When you press **VCR CONTROL**, some buttons on the remote control cannot work for operating this unit.

To operate this unit, press **DVD** or **FM/AM**.

Operating Other Manufacturers' TV

You can use the remote control to operate other manufacturers' TV.

- Refer also to the manuals supplied for the other products.
- To operate the other products, aim the remote control directly at the remote sensor on the target product.

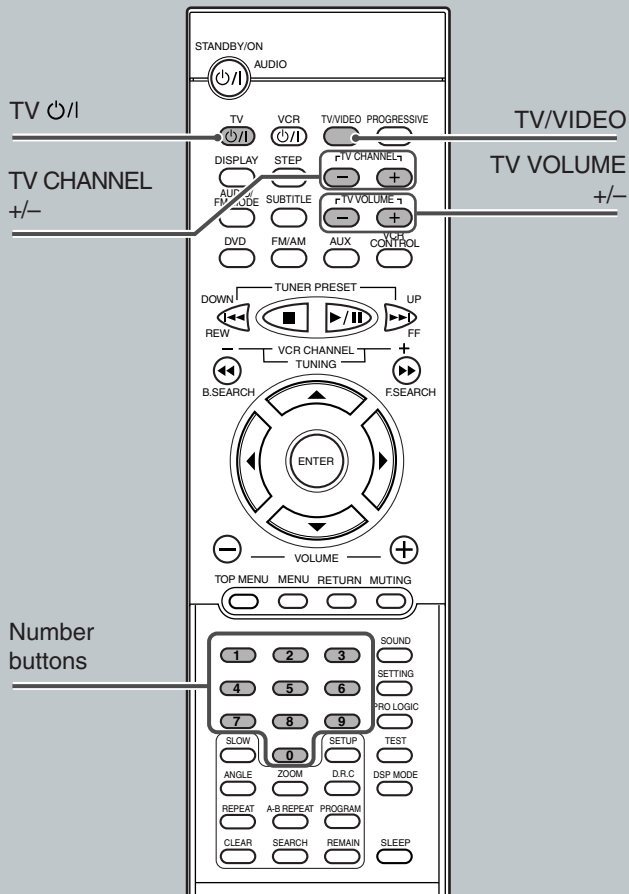

□ To change the transmittable signals for operating a TV

1. Press and hold TV \odot/I .
2. Enter manufacturer's code using buttons 1–9, and 0.
3. Release TV \odot/I .

Now, you can perform the following operations on the TV.

TV \odot/I	: Turn on or off the TV.
TV VOLUME +/-	: Adjust the volume.
TV/VIDEO	: Set the input mode (either TV or VIDEO)
TV CHANNEL +/-	: Change the channels.

4. Try to operate your TV by pressing TV \odot/I .

When your TV turns on or off, you have entered the correct code.

If there are more than one code listed for your brand of TV, try each one until the correct one is entered.

Manufacturers' codes for TV

Manufacturer	Codes
JVC	01
Hitachi	10
Magnavox	04
Mitsubishi	13
Panasonic	12, 24
RCA	07, 29
Samsung	11
Sanyo	05, 20
Sharp	02, 16, 22
Sony	03
Toshiba	09
Zenith	17

Manufacturers' codes are subject to change without notice. If they are changed, this remote control cannot operate the equipment.

To get the best performance of the unit, keep your discs and mechanism clean.

General Notes

In general, you will have the best performance by keeping your discs, and the mechanism clean.

- Store discs in their cases, and keep them in cabinets or on shelves.
- Keep the disc tray closed when not in use.

Handling Discs



- Remove the disc from its case by holding it at the edge while pressing the center hole lightly.
- Do not touch the shiny surface of the disc, or bend the disc.
- Put the disc back in its case after use to prevent warping.

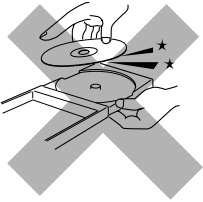

- Be careful not to scratch the surface of the disc when placing it back in its case.
- Avoid exposure to direct sunlight, temperature extremes, and moisture.



To clean the disc

Wipe the disc with a soft cloth in a straight line from center to edge.

DO NOT use any solvent—such as conventional record cleaner, spray, thinner, or benzine—to clean the disc.

Cleaning the unit

• Stains on the unit

Should be wiped off with a soft cloth. If the unit is heavily stained, wipe it with a cloth soaked in water-diluted neutral detergent and wrung well, then wipe clean with a dry cloth.

• Since the unit may deteriorate in quality, become damaged or get its paint peeled off, be careful about the following.

- DO NOT wipe it with a hard cloth.
- DO NOT wipe it strong.
- DO NOT wipe it with thinner or benzine.
- DO NOT apply any volatile substance such as insecticides to it.
- DO NOT allow any rubber or plastic to remain in contact with it for a long time.

Troubleshooting

Use this chart to help you solve daily operational problems. If there is any problem you cannot solve, contact your JVC service center.

PROBLEM	POSSIBLE CAUSE	SOLUTION
Power does not come on.	The power cord is not connected correctly.	Insert the plug into the socket.
The remote control does not work.	<ul style="list-style-type: none"> • It is too far from the center unit, or is not facing the center unit. • There is something obstructing the remote sensor. • The VCR CONTROL button has been pressed. • The battery is flat. • The battery has been inserted the wrong way round (+/-). • Sunlight is falling directly on the detector. 	<ul style="list-style-type: none"> • Come close to the center unit. • Avoid any obstacles. • Press DVD or FM/AM to operate the system. (See page 54.) • Replace the battery. • Insert the battery correctly. • Shade the remote control from direct sunlight.
No sound.	<ul style="list-style-type: none"> • There is a short in the speaker cord. • The audio cord is not connected properly. • An incorrect source has been selected. • Muting is on. • The disc is copy-protected CD. 	<ul style="list-style-type: none"> • Reconnect the speaker cord. • Connect the cord properly. (See page 9.) • Select the correct source. (See pages 12 to 17.) • Press MUTING to cancel muting. • Replace the disc.
Sound is emitted from only one speaker.	<ul style="list-style-type: none"> • The speaker cord is not connected correctly. • Left-right balance is incorrect. 	<ul style="list-style-type: none"> • Connect the cord properly. (See page 8.) • Adjust balance. (See pages 22 to 26.)
No video.	<ul style="list-style-type: none"> • The video cord is not connected properly. • TV input selection is incorrect. 	<ul style="list-style-type: none"> • Connect the cord properly. (See page 10.) • Select the correct input.
No picture is displayed on the TV screen, the picture is blurred, or the picture is divided into two parts.	<ul style="list-style-type: none"> • The scan mode is set to "P-SCAN MODE" though the system is connected to the TV which does not support the progressive video input such as a conventional TV. 	<ul style="list-style-type: none"> • Change the scan mode to "I-SCAN MODE." (See page 11.)
A disc cannot be played.	<ul style="list-style-type: none"> • The system and disc region code numbers are incompatible. • The disc causes the parental (rating) error. 	<ul style="list-style-type: none"> • Replace the disc. (See page 27.) • Enter password to change the parental (rating) level. (See page 52.)
"WRONG DISC FORMAT" appears on the TV screen.	<ul style="list-style-type: none"> • The disc is recorded with color system of PAL. • The CD-R/CD-RW does not contain any MP3 files. 	<ul style="list-style-type: none"> • Replace the disc. (See page 27.) • Replace the disc.
Pictures and sounds are distorted.	<ul style="list-style-type: none"> • The disc is dirty. • A VCR is connected between the center unit and the TV. 	<ul style="list-style-type: none"> • Clean the disc. • Connect the center unit and TV directly.
Pictures are distorted when progressive mode is selected.	<ul style="list-style-type: none"> • "Progressive Mode" may not be set appropriately for the current disc. 	<ul style="list-style-type: none"> • Change "Progressive Mode" (See page 17.)
The edge is missing on the picture image.	<ul style="list-style-type: none"> • Initial setup (TV screen size) was incorrect. 	<ul style="list-style-type: none"> • Set TV screen size correctly. (See pages 50 and 51.)
Continuous static during FM broadcasts.	<ul style="list-style-type: none"> • The received signal is too weak. • The station is too far away. • The antenna is not connected correctly. 	<ul style="list-style-type: none"> • Connect an external FM antenna (see page 6), or contact your dealer. • Select another station. • Check the connection. (See page 6.)
The system does not work correctly.	<ul style="list-style-type: none"> • Lightning or electronic noise interferes with operation of the microcomputer. • Immediately after heating the room, the unit was moved to a cold location causing condensation to form inside. 	<ul style="list-style-type: none"> • Switch power off, and remove and re-insert the power plug in the socket. • Turn off the power, plug off and leave the unit a few hours before switching power on again.
The VCR cannot be operated using this remote control.	<ul style="list-style-type: none"> • The remote control is not set for VCR operations. • The VCR is not a JVC's product. 	<ul style="list-style-type: none"> • Press VCR CONTROL to operate the VCR. (See page 54.) • This remote control can operate a JVC's VCR whose remote control code is set to A code.

Center unit (XV-THA30)

Amplifier section

Front/Center/Rear:

25 watts per channel, min. RMS at 6 ohms as 1 kHz, with no more than 10 % total harmonic distortion.

Subwoofer:

110 watts, min. RMS at 4 ohms as 100 Hz, with no more than 10 % total harmonic distortion.

Audio section

Audio input sensitivity/Impedance (at 1 kHz)

AUX IN: 500 mV/47 k Ω

Video section

Color System: NTSC

Horizontal Resolution: 480 lines

Signal-to-Noise Ratio: 68 dB

Output Level VIDEO OUT

VIDEO (Composite): 1.0 V(p-p)/75 Ω

S-VIDEO (Y): 1.0 V(p-p)/75 Ω

(C): 0.286 V(p-p)/75 Ω

COMPONENT OUT

Y: 1.0 V(p-p)/75 Ω

PB/PR: 0.7 V(p-p)/75 Ω

Tuner section

Tuning Range FM : 87.5 MHz – 108.0 MHz

AM : 530 kHz – 1 710 kHz

Usable Sensitivity FM: 8.0 dBf (0.9 μ V/75 Ω)

AM loop antenna: 650 μ V/m

General

Readable discs: DVD VIDEO, Video CD, Super Video CD, Audio CD, CD-R/RW (Audio CD, Video CD, Super Video CD, MP3 disc), DVD-R (Video format)

Power Requirements: AC 120 V \sim , 60 Hz

Power Consumption: 120 W (at operation)
2 W (in standby mode)

Dimensions (W \times H \times D): 350 mm \times 80 mm \times 365mm
(13 ¹³/₁₆ in. \times 3 ³/₁₆ in. \times 14 ³/₈ in.)

Mass: 6.5 kg (14.4lbs)

Subwoofer (SP-WA30)

Speaker: 20 cm
Bass-reflex, Magnetically Shielded

Power Handling Capacity: 110 W

Impedance: 4 Ω (min)

Frequency Range: 25 Hz to 200 Hz

Dimensions (W \times H \times D): 249 mm \times 404 mm \times 335 mm
(9 ¹³/₁₆ in. \times 15 ¹⁵/₁₆ in. \times 13 ¹/₄ in.)

Mass: 6.5 kg (14.4 lbs) (except cords)

Satellite Speakers (SP-XA30)

Speakers: 8 cm
Bass-reflex, Magnetically Shielded

Power Handling Capacity: 35 W

Impedance: 6 Ω (min)

Frequency Range: 90 Hz to 20 kHz

Length of cords: 6 m

Dimensions (W \times H \times D): 105 mm \times 119 mm \times 126 mm
(4 ³/₁₆ in. \times 4 ¹¹/₁₆ in. \times 5 in.)

Mass: 600 g (1.4 lbs) (except cords)

Rear Satellite Speakers (SP-XSA30)

Speakers: 8 cm
Bass-reflex, Magnetically Shielded

Power Handling Capacity: 35 W

Impedance: 6 Ω (min)

Frequency Range: 90 Hz to 20 kHz

Length of cords: 10 m

Dimensions (W \times H \times D): 105 mm \times 119 mm \times 126 mm
(4 ³/₁₆ in. \times 4 ¹¹/₁₆ in. \times 5 in.)

Mass: 600 g (1.4 lbs) (except cords)

Designs & specifications are subject to change without notice.

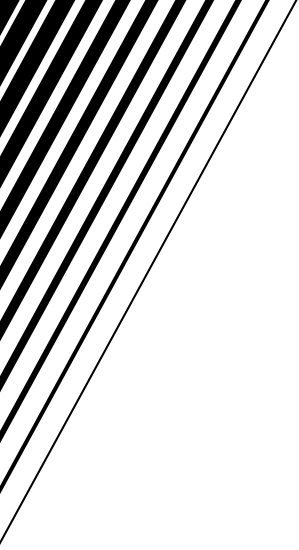

JVC
VICTOR COMPANY OF JAPAN, LIMITED